

# Behlen<sup>®</sup> COUNTRY

Farm & Ranch Equipment

Product Catalog



**Behlen<sup>®</sup>**  
**COUNTRY**  
Farm & Ranch Equipment

# Contents

## **Gates**

- 5 Heavy Duty Gates
- 8 Medium Duty Gates
- 11 Utility Gates
- 14 Gate Accessories

## **Corral Panels**

- 16 Heavy Duty Panels
- 19 Medium Duty Panels
- 20 Utility Panels
- 22 Kidding Pen Panels
- 23 Corral Panel Accessories

## **Fence Panels**

- 24 Fence Panels

## **Equine Equipment**

- 26 Stalls
- 28 Modular Shelter Kits
- 32 Modular Shelter Components
- 34 Stall Feeders
- 36 Feed Bunks, Racks, Storage
- 37 Waterers

## **Feeding Equipment**

- 38 Bale Feeders
- 44 Feed Bunks
- 46 Mineral Feeders
- 47 Hog Feeders, Troughs
- 48 Calf Creep Feeders

## **Specialty Products**

- 49 Calf Hutches, Anchor Stakes, Post Drivers

## **Tanks & Waterers**

- 50 Galvanized Stock Tanks
- 52 Poly Stock Tanks
- 54 Energy-Free Waterers
- 56 Electric & Insulated Waterers
- 58 Tanks & Waterers Accessories

## **Cattle Equipment**

- 60 Chutes & Headgates
- 66 Chute Trailers & AI Cage
- 67 Headgates
- 68 Scale Accessories
- 69 Portable Care Center
- 70 Unsheeted System Components
- 71 Unsheeted System Kits

## **3-Point Equipment**

- 74 Rotary Cutters
- 76 Grader Blades & Hitch `N Plow
- 78 Box Blades
- 79 Landscape Rakes
- 80 Rotary Tiller
- 81 Tillage Discs
- 82 Middle Buster & Sub Soiler
- 83 Dirt Scoop & Cultivator
- 84 Hay Moving Implements
- 86 Lifting Implements
- 87 Drag Harrows & Land Plane
- 88 Miscellaneous Equipment
- 89 3-Point Replacement Parts
- 90 Sub-Compact Implements

## **Dog Kennels**

- 92 Magnum Dog Kennel™
- 94 Chain Link Kennel
- 95 Kennel Accessories





**Behlen Country<sup>®</sup>**

# Gates, Corral Panels

## Gate & Corral Panel Performance:

With our good, better, best approach, every Behlen gate and corral panel is designed to perform. Rugged, resilient and field proven, simply pick the level of performance you need for your site.

▶ <b>Heavy Duty</b>	▶ <b>Medium Duty</b>	▶ <b>Utility</b>
<p>Designed to withstand the most damaging conditions, the Heavy Duty collection features 3 finishes, heavy gauge steel tubing, special Z-braces, and saddle weld joints, so you can count on them to last.</p> <p><b>Gates:</b></p> <ul style="list-style-type: none"> <li>• Rugged 2" and 1-5/8" diameter tubes</li> <li>• Hefty 14 or 16 gauge steel</li> <li>• Powder Coat, Galvanized or Hot-Dipped Galvanized Finish</li> </ul> <p><b>Corral Panels:</b></p> <ul style="list-style-type: none"> <li>• Rugged 2" diameter tube</li> <li>• Hefty 16 &amp; 18 gauge steel</li> <li>• Powder Coat, Galvanized or Hot-Dipped Galvanized Finish</li> <li>• Heavy Duty 2" diameter arch gates, entrance panels and inverted arches</li> </ul>	<p>Our Medium Duty lineup is great for 365-day wear and tear. Armed with tough materials and durable finishes, Medium Duty thrives in heavy traffic and bad weather.</p> <p><b>Gates:</b></p> <ul style="list-style-type: none"> <li>• Rugged 1-5/8" diameter tube with wire mesh panels</li> <li>• Heavy 16 &amp; 18 gauge steel</li> <li>• Resilient Powder Coated or Galvanized Finish</li> </ul> <p><b>Corral Panels:</b></p> <ul style="list-style-type: none"> <li>• Rugged 2" and 1-5/8" diameter tube</li> <li>• 16 &amp; 18 gauge steel</li> <li>• Powder Coat or Galvanized Finish</li> <li>• Medium Duty 1-5/8" diameter entrance panels and arch gates</li> </ul>	<p>For everyday performance that will last, and last, the Utility lineup is made for the job. Big on value, and low on maintenance, Utility works as hard as you do.</p> <p><b>Gates:</b></p> <ul style="list-style-type: none"> <li>• Utility 1-5/8" diameter tube</li> <li>• Utility 20 gauge steel</li> <li>• Resilient Powder Coated or Galvanized Finish</li> </ul> <p><b>Corral Panels:</b></p> <ul style="list-style-type: none"> <li>• Utility 1-5/8" diameter tube</li> <li>• Utility 18/20 gauge steel</li> <li>• Resilient Powder Coated or Galvanized Finish</li> </ul>

# Gate & Corral Panel Finish Options



## Premium Powder Coat

Behlen Country Premium Powder Coat provides a long lasting, weather resistant finish.

This unique process starts with:

1. Automotive grade, high tensile steel

Followed by a state-of-the-art wash system:

### 2. 6 stage wash and chemical etch

- |   |  |
|---|--|
| 1) Alkaline cleaner removes oils, soils, etc. | 4) Phosphate preps material for adhesion |
| 2) De greasing Rinse                          | 5) Spot-free Rinse                       |
| 3) Rinse                                      | 6) Reverse osmosis rinse                 |

*(This process ensures maximum adherence of top coat for a no blister, no peel tough finish)*

### 3. Behlen Country Premium Powder Coat

- a. Electrostatically applied, ensures no runs and even coverage
- b. 375° baked on finish is hard as nails
- c. UV resistant (fade resistant)
- d. Similar to the process used in the automotive and appliance industry

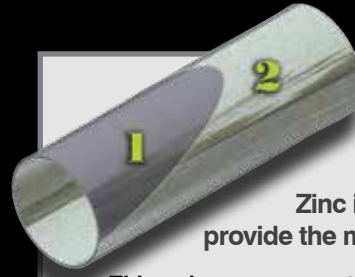

## Hot-Dipped Galvanized

Zinc is heavily bonded with steel to provide the most corrosion resistant finish.

This unique process starts with:

1. Automotive grade, high tensile steel
2. Followed by Behlen Country's exclusive on-site hot-dip galvanizing process

- a. Increased life due to zinc coating on the inside as well as the outside of product
- b. Provides the ultimate protection against corrosion and insures a lasting finish
- c. For example: a 16' 2" gate has over 7 pounds of zinc applied over automotive grade, high tensile steel



## GalvSmart

Behlen Country's exclusive "double coat" finish creates a superior rust protection.

The GalvSmart process starts with:

1. Automotive grade, high tensile, pre-galvanized steel

Followed by a state-of-the-art wash system:

### 2. 6 stage wash and chemical etch

- |   |  |
|---|--|
| 1) Alkaline cleaner removes oils, soils, etc. | 4) Phosphate preps material for adhesion |
| 2) De greasing rinse                          | 5) Spot-free rinse                       |
| 3) Rinse                                      | 6) Reverse osmosis rinse                 |

*(This process ensures maximum adherence of top coat for a no blister, no peel tough finish)*

### 3. Behlen Country premium silver powder coat to finish the entire product

- a. Electrostatically applied, ensures no runs and even coverage
- b. 375° baked-on finish is hard as nails
- c. UV resistant (fade resistant)
- d. Similar to the process used in the automotive and appliance industry

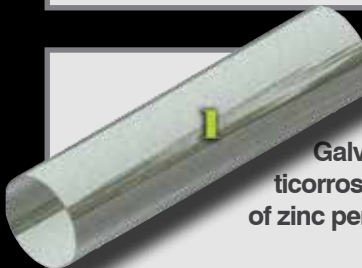

## Galvanized

Galvanized steel is an effective anticorrosion resistant finish, with layers of zinc permanently bonded to the steel.

1. Automotive grade, high tensile, pre-galvanized steel

- a. All welds are coated with zinc rich paint for increased protection



## Premium Powder Coat with Zinc Primer

Zinc Rich Primer provides a base coating of extra anti-corrosive protection.

*Available on select products.*

This unique process starts with:

1. Automotive grade, high tensile steel

Followed by a state-of-the-art wash system:

### 2. 6 stage wash and chemical etch

- |   |  |
|---|--|
| 1) Alkaline cleaner removes oils, soils, etc. | 4) Phosphate preps material for adhesion |
| 2) De greasing rinse                          | 5) Spot-free rinse                       |
| 3) Rinse                                      | 6) Reverse osmosis rinse                 |

*(This process ensures maximum adherence of top coat for a no blister, no peel tough finish)*

### 3. Zinc rich primer provides another layer of protection for increased life of finish

### 4. Behlen Country premium powder coat paint to finish the entire product

- a. Electrostatically applied, ensures no runs and even coverage
- b. 375° baked-on finish is hard as nails
- c. UV resistant (fade resistant)
- d. Similar to the process used in the automotive and appliance industry



# Gates

## Heavy Duty Gates



Our heavy duty gates keep the toughest stock contained.



### 2" • 16 Gauge Gate Heavy Duty Gate

#### *Best Value in a Heavy Duty Gate*

- Designed for crowding livestock areas
- Heavy, all 16 gauge steel tubing
- Horizontal tubes are notched and welded for additional strength
- Vertical Z-braces offer extra strength and support
- 6 Rails, 50" High
- 3/4" x 12" long threaded bolt hooks for hinges
- Welded latch and 36" long plated chain
- 18 and 20 foot long gates come standard with 3 bolt hooks for added support
- Long-lasting, UV resistant powder coat finish

AVAILABLE COLORS: ● RED ● GREEN

LENGTH	LBS.	VERT. 'Z' BRACES	RED ITEM NO.	GREEN ITEM NO.
4'	42	0	40120041	40120042
6'	58	0	40120061	40120062
8'	80	1	40120081	40120082
10'	97	1	40120101	40120102
12'	113	1	40120121	40120122
14'	134	2	40120141	40120142
16'	151	2	40120161	40120162
18'	172	3	40120181	40120182
20'	188	3	40120201	40120202

**NOTE:** ALL GATES ARE 4" LESS THAN LISTED LENGTH TO ALLOW FOR GATE HARDWARE AND PROPER CLEARANCE.



## 2" · 14 Gauge Super Duty Gate

AVAILABLE COLORS: ● GREEN

LENGTH	LBS.	VERTICAL BRACES	ITEM NO.
8'	106	1	40128082
10'	124	1	40128102
12'	150	2	40128122
14'	169	2	40128142
16'	203	3	40128162



Hinge



Latch



- Heavy 3" collared hinges with 12" long 1" dia. plated threaded bolt complete with hardware
- Heavy duty, spring loaded piston latch
- Saddle welded braces for durability
- Square corners for increased animal safety
- Horizontal tubes are notched and welded for additional strength
- 6 Rails, 60" High
- Long-lasting, UV resistant powder coat finish

**NOTE:** ALL GATES ARE 4" LESS THAN LISTED LENGTH TO ALLOW FOR GATE HARDWARE AND PROPER CLEARANCE.

## 2" · 16 Gauge Collared Hinge Gate

AVAILABLE COLORS: ● GREEN

LENGTH	LBS.	VERTICAL BRACES	ITEM NO.
4'	43	0	40162042
6'	59	0	40162062
8'	81	1	40162082
10'	98	1	40162102
12'	114	1	40162122
14'	135	2	40162142
16'	152	2	40162162
18'	173	3	40162182
20'	189	3	40162202



Hinge



- Heavy collared hinges with 11" long, 3/4" dia., plated, threaded bolt, complete with hardware
- 3 Heavy collared hinges on 18 and 20 foot gates
- Vertical Z-braces offer extra strength and support
- Square corners for increased animal safety
- Horizontal tubes are notched and welded for additional strength
- 6 Rails, 50" High
- Welded latch and 36" long plated chain
- Long-lasting, UV resistant powder coat finish

**NOTE:** ALL GATES ARE 4" LESS THAN LISTED LENGTH TO ALLOW FOR GATE HARDWARE AND PROPER CLEARANCE.





## 2" • 16 Gauge Hot-Dipped Galvanized Gate

AVAILABLE COLORS:  HOT-DIPPED GALVANIZED

- Completely Hot-Dipped Galvanized after fabrication for coverage inside and out
- The ultimate in tough, durable, long-life finish
- Square corners for increased animal safety
- Horizontal tubes are notched and welded for additional strength
- Extra heavy 11 ga. vertical brace
- 6 Rails, 50" high
- 3/4" x 12" long threaded bolt hooks for hinges
- Welded latch and 36" long plated chain

**NOTE:** ALL GATES ARE 4" LESS THAN LISTED LENGTH TO ALLOW FOR GATE HARDWARE AND PROPER CLEARANCE.

LENGTH	LBS.	VERTICAL BRACES	ITEM NO.
4'	47	0	40129049
6'	63	0	40129069
8'	85	1	40129089
10'	103	1	40129109
12'	118	1	40129129
14'	139	2	40129149
16'	156	2	40129169

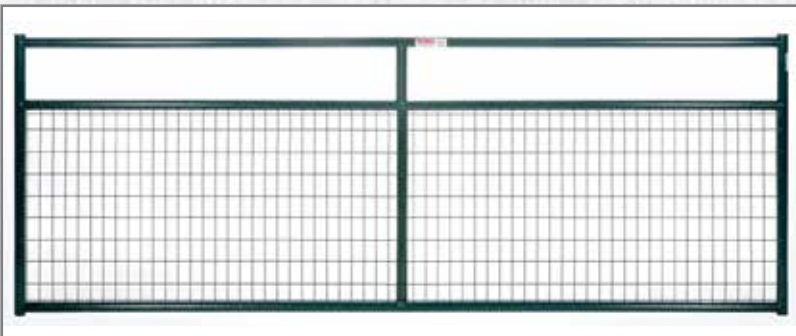

## 2" • 16 Gauge Heavy Duty 2" x 4" Mesh Gate

AVAILABLE COLORS:  GREEN

- 2" diameter, 16 gauge frame
- 2" x 4" 6 gauge mesh-the heaviest mesh gate available
- Mesh wire is welded twice as much as the 1-5/8" gate for safety and strength
- Bolt on hinges make the gate reversible for any application, like double gates & small animal pens

**NOTE:** ALL GATES ARE 4" LESS THAN LISTED LENGTH TO ALLOW FOR GATE HARDWARE AND PROPER CLEARANCE.

LENGTH	LBS.	VERT. 'Z' BRACES	ITEM NO.
4'	40	0	40135042
6'	50	0	40135062
8'	68	1	40135082
10'	80	1	40135102
12'	91	1	40135122
14'	108	2	40135142
16'	120	2	40135162

# Gates

## Medium Duty Gates

Our reliable medium duty gates will fit your needs perfectly.



### 1 5/8" • 2" x 4" Wire-Filled Gate

- 6 gauge mesh is 20% heavier than competition
- Ideal for yards, confinement for small animals, or as a non-climb horse gate
- Bolt-on hinges allow gate to be easily reversed when hanging two gates together
- Square corners for animal safety
- Easily converted to small animal panels
- 50" High
- Saddle welded braces for increased animal safety

**NOTE:** ALL GATES ARE 4" LESS THAN LISTED LENGTH TO ALLOW FOR GATE HARDWARE AND PROPER CLEARANCE.

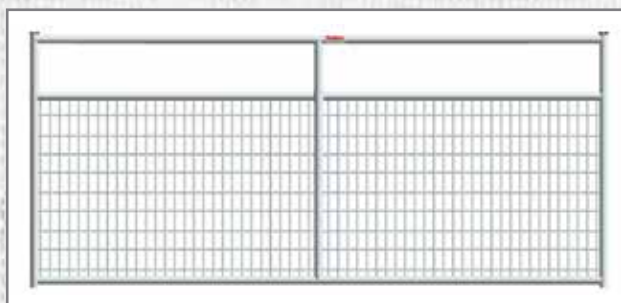

AVAILABLE COLORS: ● GRAY ● GREEN ○ GALVANIZED

Square Corner Wire-Filled • Powder Coated				
LENGTH	LBS.	VERT. BRACES	GRAY ITEM NO.	GREEN ITEM NO.
3'	19	0	40132037	40132032
4'	23	0	40132047	40132042
6'	31	0	40132067	40132062
8'	42	1	40132087	40132082
10'	51	1	40132107	40132102
12'	60	1	40132127	40132122
14'	71	2	40132147	40132142
16'	80	2	40132167	40132162

Square Corner Wire-Filled • Galvanized			
LENGTH	LBS.	VERT. BRACES	ITEM NO.
3'	20	0	40183038
4'	25	0	40183048
6'	33	0	40183068
8'	46	1	40183088
10'	55	1	40183108
12'	64	1	40183128
14'	76	2	40183148
16'	85	2	40183168



## 1 5/8" • Hog Mesh Gate

- Heaviest mesh gate in the industry
- Galvanized for long life
- 6 gauge mesh woven in a "hog" pattern is 40% heavier than the competition
- Variable spacing in mesh is best for small animals
- Bolt-on hinges allow gate to be easily reversed when hanging two gates together
- Square corner
- 50" High

**NOTE:** ALL GATES ARE 4" LESS THAN LISTED LENGTH TO ALLOW FOR GATE HARDWARE AND PROPER CLEARANCE.



AVAILABLE COLORS:  GALVANIZED

LENGTH	LBS.	VERT. BRACES	ITEM NO.
4'	22	0	40115048
6'	30	0	40115068
8'	40	1	40115088
10'	48	1	40115108
12'	56	1	40115128
14'	66	2	40115148
16'	74	2	40115168
18'	82	3	40115188

## 1 5/8" • 7 Rail Gate

- Rails are spaced closer together at the bottom of the gate
- Horizontal tubes are notched and welded for additional strength
- Vertical Z-braces offer extra strength and support
- 7 Rail, 50" High
- 5/8" x 6" screw hook for hinges
- Plated chain and snap assembly
- Long-lasting UV resistant powder coat finish

**NOTE:** ALL GATES ARE 4" LESS THAN LISTED LENGTH TO ALLOW FOR GATE HARDWARE AND PROPER CLEARANCE.



AVAILABLE COLORS:  GREEN

LENGTH	LBS.	VERT. 'Z' BRACES	GREEN ITEM NO.
4'	23	0	40169042
6'	32	1	40169062
8'	39	1	40169082
10'	53	2	40169102
12'	63	2	40169122
14'	71	3	40169142
16'	79	3	40169162

# 1 5/8" • Collared Hinge Gate

## Square or Round Corners

- 1-5/8" 16/20 Gauge
- 6 Rail, 50" Tall
- Heavier frame for increased strength and durability
- Vertical Z-Braces offer extra strength and support
- Plated chain and snap assembly
- Long-lasting, UV resistant powder coat finish
- Collared hinges
- Round & square corners available
- Green

AVAILABLE COLORS: ● GREEN

**NOTE:** ALL GATES ARE 4" LESS THAN LISTED LENGTH TO ALLOW FOR GATE HARDWARE AND PROPER CLEARANCE.

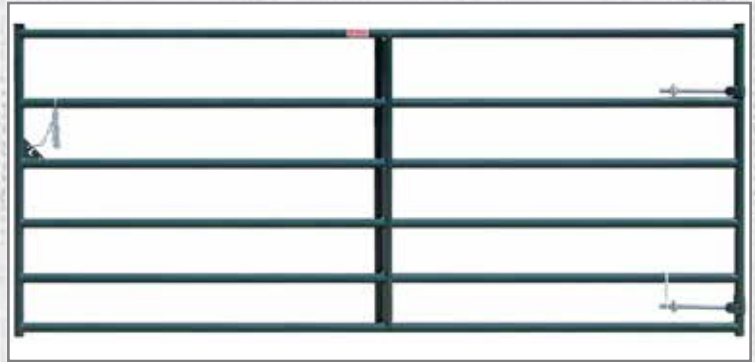

Square Corner Collared Hinge Gates			
LENGTH	LBS.	VERT. BRACES	ITEM NO.
4'	30	0	40140042
6'	37	0	40140062
8'	47	1	40140082
10'	54	1	40140102
12'	64	2	40140122
14'	72	2	40140142
16'	81	3	40140162
18'	89	3	40140182
20'	97	3	40140202

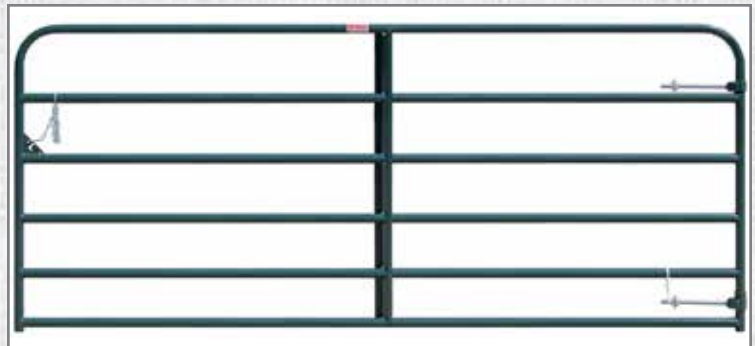

Round Corner Collared Hinge Gates			
LENGTH	LBS.	VERT. BRACES	ITEM NO.
4'	29	0	40141042
6'	37	0	40141062
8'	47	1	40141082
10'	55	1	40141102
12'	66	2	40141122
14'	74	2	40141142
16'	84	3	40141162
18'	97	3	40141182
20'	107	3	40141202



# Gates

## Utility Gates

Our most popular gates for your home and ranch.



### 1<sup>5</sup>/<sub>8</sub>" • Utility Gate Our Best Selling Gate!

- Combines lower cost with great features
- Designed for tame animals, entrances to pastures and driveways
- Horizontal tubes are notched and welded for a smooth finish
- Vertical Z-braces offer support
- 6 Rail, 50" High
- 5/8" x 6" screw hooks for hinges - 18' gate comes standard with 3 screw hooks
- Welded latch and 36" plated chain
- Long-lasting, UV resistant powder coat finish

AVAILABLE COLORS: ● RED ● GREEN ● GRAY

LENGTH	LBS.	VERT. 'Z' BRACES	RED ITEM NO.	GREEN ITEM NO.	GRAY ITEM NO.
4'	18	0	40130041	40130042	40130047
6'	25	0	40130061	40130062	40130067
8'	33	1	40130081	40130082	40130087
10'	40	1	40130101	40130102	40130107
12'	46	1	40130121	40130122	40130127
14'	55	2	40130141	40130142	40130147
16'	61	2	40130161	40130162	40130167
18'	72	3	40130181	40130182	40130187

**NOTE:** ALL GATES ARE 4" LESS THAN LISTED LENGTH TO ALLOW FOR GATE HARDWARE AND PROPER CLEARANCE.



## 1<sup>5</sup>/<sub>8</sub>" • Utility Gate 6 Rail Galvanized Gate

- Ideal for any non-crowding application such as pastures, field entrances, coastal or corrosive areas
- Horizontal tubes are notched and welded for a smooth finish
- Vertical Z-braces offer support
- 6 Rail, 50" High
- 5/8" x 6" screw hooks for hinges
- 18' gate comes standard with 3 screw hooks
- Welded latch and 36" plated chain
- Galvanized finish

**NOTE:** ALL GATES ARE 4" LESS THAN LISTED LENGTH TO ALLOW FOR GATE HARDWARE AND PROPER CLEARANCE.



AVAILABLE COLORS:  GALVANIZED

LENGTH	LBS.	VERT. 'Z' BRACES	ITEM NO.
4'	20	0	40113048
6'	27	0	40113068
8'	37	1	40113088
10'	44	1	40113108
12'	51	1	40113128
14'	60	2	40113148
16'	67	2	40113168
18'	78	3	40113188

## 1<sup>5</sup>/<sub>8</sub>" • GalvSmart Gate

- Provides the benefit of powder coating over galvanized tubing - the best of both worlds
- Square corners for increased animal safety
- Horizontal tubes are notched and welded for additional strength
- Vertical Z-braces offer extra strength and support
- 6 Rail, 50" High
- 5/8" x 6" screw hooks for hinges
- 18' gate comes standard with 3 screw hooks
- Latch and 36" long plated chain

**NOTE:** ALL GATES ARE 4" LESS THAN LISTED LENGTH TO ALLOW FOR GATE HARDWARE AND PROPER CLEARANCE.



AVAILABLE COLORS:  GALVSMART

LENGTH	LBS.	VERT. 'Z' BRACES	ITEM NO.
4'	20	0	40194048
6'	27	0	40194068
8'	37	1	40194088
10'	44	1	40194108
12'	51	1	40194128
14'	60	2	40194148
16'	67	2	40194168
18'	78	3	40194188



## Classic Panel Gate

- Galvanized panel construction adds long life and rigidity with rust resistance.
- Panel edges are turned for safety
- 5 Panel
- 50" High
- Timeless design

**NOTE:** ALL GATES ARE 4" LESS THAN LISTED LENGTH TO ALLOW FOR GATE HARDWARE AND PROPER CLEARANCE.



### Panel Gate Accessories

DESCRIPTION	LBS.	ITEM NO.
Chain & Swivel Fastener	1	1488039
Hinge, Steel W/ Tapping Screw	2	42151018
Screw Hook 5/8" X 6"	1	3208159
Bolt Hook 5/8" X 12"	1	42900038

AVAILABLE COLORS:  GALVANIZED

LENGTH	LBS.	ITEM NO.
4'	21	42151048
6'	32	42151068
8'	44	42151088
10'	51	42151108
12'	59	42151128
14'	66	42151148
16'	78	42151168

## Landowner Gate

- Visibility ensured both day and night with reflective decals on gate
- Heavy collared hinge keeps gate from sagging for years of use
- Long lasting, eco-friendly powder coat green paint
- Heavy 2" 18 gauge high tensile strength steel
- Heavy duty collared hinges make theft or removal of gate difficult
- Plated, lockable chain standard
- Accepts most padlocks (not included)
- Customize to fit any opening by drilling additional holes
- 12 to 20 foot coverage with one gate
- Extends easily with 1-3/4" 16 gauge telescoping tube
- Adjustable every 24" with holes pre-drilled
- Strong 3/8" bolt used to secure telescoping tube
- Opens easily in any weather due to high ground clearance
- Attractive alternative to standard yard gates



AVAILABLE COLORS:  GREEN

LENGTH	LBS.	ITEM NO.
Gate Extends 12' to 20'	37	40100122

**NOTE:** ALL GATES ARE 4" LESS THAN LISTED LENGTH TO ALLOW FOR GATE HARDWARE AND PROPER CLEARANCE.



# Gate Accessories

Find the gate accessories you need here.

## A. Bolt Hook Assembly

- Full 12" of thread
- Easily adjustable w/ double nut & washer system
- Available in 5/8" dia. for 1-5/8" gates & 3/4" dia. for 2" gates

## B. Screw Hook

- 5/8" X 6" Threaded
- Zinc plated
- Easy to install, provides excellent support

## C. Gate Hinges

- Zinc plated, includes hardware

## D. Chain & Snap Assembly

- Pre-assembled, ready to use

## E. Gate Brackets

- Use to attach gates to walls
- Accommodates 2" gates

## F. Hanging Clip

- Use to attach gate or corral panel to post or flat surface

## G. Horse Gate Latch

- Allows gate to be opened from horseback
- Fits both 1-5/8" gates or 2" gates
- Adjustable height and reversible

## H. Double Piston Lever Latch

- Allows easy opening of gate from horseback
- Includes safety lock
- U-Bolts included
- For a 2" only

## I. Removable Gate Post

- Quickly connect two gates with this removable gate post
- Easy to install
- Available in galvanized
- Available in gray or green powder coat paint

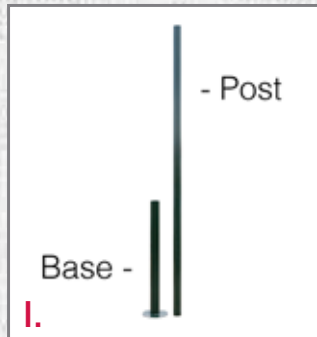

DESCRIPTION	LBS.	SHIP UPS	ITEM NO.
A. Bolt Hook 5/8" x 12" (for 1 5/8" gates)	-	✓	42900038
A. Bolt Hook 3/4" x 12" (for 2" gates)	-	✓	40300029
B. Screw Hook 5/8" x 6"	-	✓	3208159
C. Plated Hinge for 2" gate	-	✓	40300019
C. Plated Hinge for 1 5/8" gate	-	✓	40113018
D. 2' Chain & Snap Assembly	-	✓	1488039
E. Bracket, 90° Corner	1	✓	40100037
E. Bracket, Flat	1	✓	40100047
F. Hanging Clip - 2"	1	✓	35600295
F. Hanging Clip - 1 5/8"	1	✓	35125195
G. Horse Gate Latch (Gray)	10	✓	44112207
H. Double Piston Lever Latch (Green)	15	✓	44110132
I. Removable Gate Post Galvanized	51	✓	44112009
I. Removable Gate Post Gray	51	✓	44112007
I. Removable Gate Post Green	51	✓	44112002





### I. Gate Rack

- Heavy 3" channel construction
- Tripod cross bracing for added stability
- Four places to hang gates
- Designed with upper and lower level (for longer, heavier gates) on each side
- May be anchored to concrete or asphalt, anchor bolts not included
- Some assembly required
- Holds up to 40 - 2" gates

### J. Gate/Kennel Rack Combo

- Heavy 3" channel construction
- Tripod cross-bracing for added stability
- Designed with gates to be hung on lower level one side and upper level both sides
- Kennels to be stored on one side of the lower level
- Some assembly required
- Holds up to 30 - 2" gates

### K. Single Tier Rack

- Heavy 3" channel construction
- Tripod cross-bracing for added stability
- Designed with gates to be hung on both sides
- Some assembly required
- Holds up to 20 - 2" gates

### L. Gate Hardware Packages

**Behlen Country hardware packages are weatherproof and sun-resistant. No other livestock equipment manufacturer offers this easy-to-use, complete kit. Offer your customers something unique!**

- High quality, rust-resistant, plated hardware compared to painted
- Chain attached after fabrication which leaves the gate with the best possible finish. Chain is NOT welded to the gate which can leave a hole in the gate and a rusty spot for decreased life.
- No worries with installation as Behlen Country includes gate installation instructions with every package.
- Strong, UV resistant covering on hardware packages for extended life.
- Easy identification for individual ordering with the large, easy-to-read barcode.

DESCRIPTION	LBS.	SHIP UPS	ITEM NO.
I. Gate Rack - 8' x 12'	285	-	82100307
J. Gate/Kennel Rack Combo	272	-	82100107
K. Single Tier Rack	220	-	82100207
<b>L. Hardware Packages</b>			
<b>Pkg. 1:</b> Two 5/8" x 6" Screw Hooks, Two 1 5/8" Hinges, Chain with Snap and Hardware	-	✓	40900158
<b>Pkg. 2:</b> Two 3/4" x 12" Bolt Hooks, Two 2" Hinges, Chain and Hardware	-	✓	40900108
<b>Pkg. 3:</b> Three 3/4" x 12" Bolt Hooks, Three 2" Hinges, Chain and Hardware	-	✓	40900118
<b>Pkg. 4:</b> Two 5/8" x 6" Screw Hooks, Two Panel Gate Hinges and Chain Assembly with Snap	-	✓	40900188
<b>Pkg. 5:</b> Two 5/8" x 12" Bolt Hooks and Two 1 5/8" Hinges	-	✓	40900198
<b>Pkg. 6:</b> Three 5/8" x 6" Screw Hooks and Three 1 5/8" Hinges	-	✓	40900208
<b>Pkg. 7:</b> Two 5/8" x 6" Screw Hooks and One 1 5/8" Hinge	-	✓	40900138
<b>Pkg. 8:</b> Three 5/8" x 6" Screw Hooks and Two 1 5/8" Hinges	-	✓	40900148

# Heavy Duty Corral Panels



Rugged corral panels for even tougher stock.

## How to calculate your round pen:

1.) To find the number of panels needed, multiply the desired diameter (straight line passing through the center of the circle) by 3.14. This will determine the circumference (the distance around the circle).

2.) Divide the circumference by the length of panels being used. This will equal the number of panels needed.

ROUND PEN CHART																	
DIAMETER OF HOLDING AREA (FEET)																	
	20'	25'	30'	35'	40'	45'	50'	55'	60'	65'	70'	75'	80'	85'	90'	95'	100'
10' PANEL	6	8	9	11	13	14	16	17	19	20	22	24	25	27	28	30	31
12' PANEL	5	7	8	9	10	12	13	14	15	17	18	20	21	22	24	25	26

**NUMBER OF PANELS NEEDED**

**NOTE:** SIZES ARE APPROXIMATE. QUANTITIES ABOVE INCLUDE ENTRANCE PANEL OF SAME LENGTH AS CORRAL PANEL. PEN DIAMETERS WILL VARY DEPENDING ON SIZE OF ENTRANCE PANEL OR ARCH GATE.

## 2" • 16 Gauge Panel 5 Rail • 72" Tall

- Designed for training horses in round pens
- When used in a round pen, these panels maximize safety:
  - ▶ 18" extra room between bottom rail and ground for leg clearance
  - ▶ Square corners and tight pin connectors reduce space to 1" between panels
  - ▶ Straight leg design eliminates catch point
- Behlen Country's tallest corral panel
- 14 gauge formed braces on both sides
- 5 Rails
- Long-lasting UV resistant premium powder coat finish
- All 16 gauge for added durability and strength

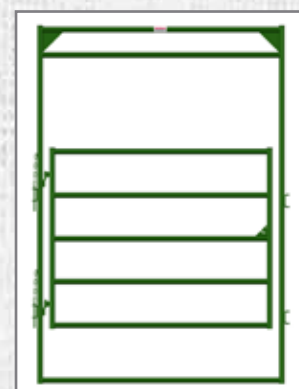
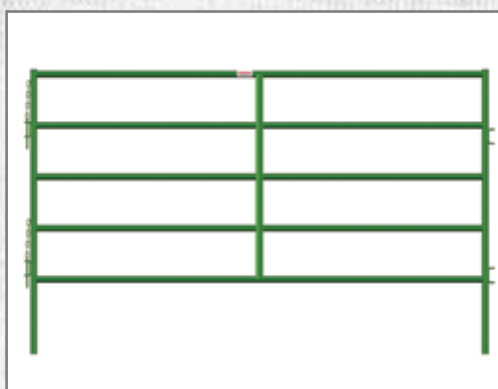

AVAILABLE COLORS: ● GREEN

DESCRIPTION	LBS.	VERT. BRACE	ITEM NO.
10' Corral Panel	89	1	44149202
6' x 9' Arch Gate	75	-	44149232

**NOTE:** ALL CORRAL PANELS ARE 4" LESS THAN LISTED LENGTH TO ALLOW PROPER CLEARANCE AND INSTALLATION.





## 2" • 16 Gauge XT Corral Panels - 6 Rail • 72" Tall

AVAILABLE COLORS: ● GRAY ○ HOT-DIPPED GALVANIZED

POWDER COATED	LBS.	VERT. BRACE	ITEM NO.
12' Corral Panel	92	1	44131127
6' x 9' Arch Gate	75	-	44131017
12' Entrance Panel Arch w/6' x 7' Gate	114	-	44131037

HOT-DIPPED GALVANIZED	LBS.	VERT. BRACE	ITEM NO.
12' Corral Panel	97	1	44131129
6' x 9' Arch Gate	84	-	44131019
12' Entrance Panel Arch w/6' x 7' Gate	122	-	44131039

**NOTE:** ALL CORRAL PANELS ARE 4" LESS THAN LISTED LENGTH TO ALLOW PROPER CLEARANCE AND INSTALLATION.

- Ideal for round pens, portable stalls and cattle corrals
- Square corner design and chain connectors enhance safety while providing a strong, secure, corral system
- Chain hookups are simple and easy to attach ideal for uneven ground. Butterfly clamps are optional
- Our unique J-leg design has a small contact point with ground to prevent unwanted panel movement
- 1-5/8" one piece vertical brace is formed and welded for maximum strength and stability
- Hot-dipped galvanized option is coated both inside and out for the longest life
- 6 Rail
- Entrance Panel has 7' Tall Arch



Butterfly Clamp



Chain Hookup

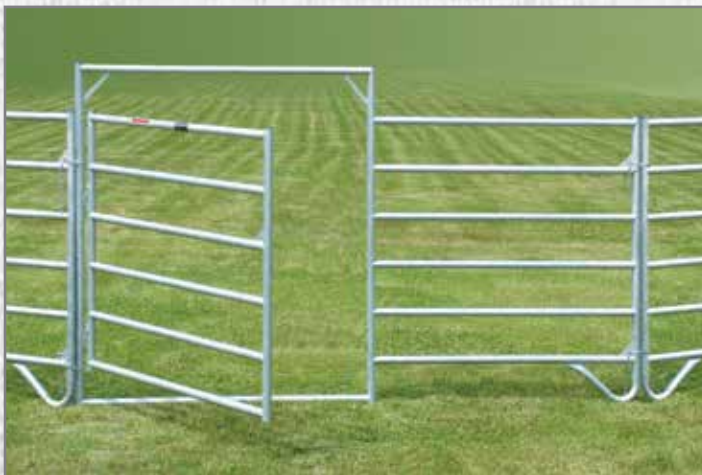



## 2" · 16 Gauge Panel

### Crowding Corral Panel - 66" Tall

- Designed specifically for crowding situations
- Includes square corners and J-legs
- Behlen Country's pin hookups:
  - ▶ Are easy to use
  - ▶ Reduce space between panels
  - ▶ Are usable on uneven ground
  - ▶ Allow 3 or 4 panels to be fastened together at a common point
- 1-5/8" one piece vertical brace is formed and welded for maximum strength and stability
- Our unique J-leg design has a small contact point with the ground to prevent unwanted panel movement
- 6 Rails (Entrance Panel is 4' wide and has a 7' Tall Arch)
- Recommended for use with Behlen Country Cattle Management Systems
- Long-lasting UV resistant premium powder coat paint



AVAILABLE COLORS: ● GREEN

DESCRIPTION	LBS.	VERT. BRACES	ITEM NO.
8' Corral Panel	80	1	44123082
10' Corral Panel	95	1	44123102
12' Corral Panel	110	1	44123122
14' Corral Panel	130	2	44123142
16' Corral Panel	145	2	44123162
10' Entrance Panel with 4' Gate	114	-	44123022

**NOTE:** ALL CORRAL PANELS ARE 4" LESS THAN LISTED LENGTH TO ALLOW PROPER CLEARANCE AND INSTALLATION.

## Inverted Arches

- Arch available in 10' and 12'
- Made of extra heavy, rectangular steel tubing:
  - ▶ Bottom tubing is made of 3/16" thick material
  - ▶ Uprights are made of 11 ga. material
- Optional Double Piston Gate Latch can be used with 2" gate
- Can be used with our 1-5/8"-16 gauge or 2"-16 gauge Crowding Corral Panels
- Pin hookups:
  - ▶ Are easy to use
  - ▶ Reduce space between panels
  - ▶ Are usable on uneven ground
  - ▶ Allow 3 or 4 way connections for pens
- Recommended for use with Behlen Country Cattle Management Systems
- Long-lasting UV resistant powder coat paint



AVAILABLE COLORS: ● GREEN

DESCRIPTION	LBS.	ITEM NO.
10' Arch Gate	123	40168102
12' Arch Gate	134	40168122

**NOTE:** If a double piston gate latch is ordered, U-Brackets are required.

2" · 16 GAUGE GATE			
LENGTH	LBS.	VERT. 'Z' BRACES	GREEN ITEM NO.
8'	80	1	40120082
10'	97	1	40120102

### IMPORTANT NOTES:

- IT IS RECOMMENDED THAT THE 2" 16 GA. GATE BE USED WITH THE INVERTED ARCH.
- GATES USED WITH INVERTED ARCHES ARE TO BE ORDERED THE NEXT SIZE SMALLER THAN THE ARCH GATE. (EX: 10' INVERTED ARCH WILL USE AN 8' GATE)



# Corral

## Medium Duty Corral Panels



Reliable corral panels for your home and ranch.

### 1<sup>5</sup>/<sub>8</sub>" • 16 Gauge Panel Corral Panel - 60" Tall

*Behlen Country's Best Value for the Cattle Producer!*

AVAILABLE COLORS: ● RED ● GREEN

- Designed with square corners, J-legs and pin hookups, these corral panels are built for rough use
- Pin hookups:
  - ▶ Are easy to use
  - ▶ Reduce space between panels
  - ▶ Are usable on uneven ground
  - ▶ Allow 3 or 4 connections for pens
- Our unique J-leg design has a small contact point with ground to prevent unwanted panel movement
- Compatible with Big Valley Cattle Management Systems
- Entrance Panel has 7' Tall Arch
- Long-lasting UV resistant powder coat finish



4 Way Connection



Pin Hookup

DESCRIPTION	LBS.	VERT. BRACES	RED ITEM NO.	GREEN ITEM NO.
8' Corral Panel	61	1	44120081	44120082
10' Corral Panel	77	1	44120101	44120102
12' Corral Panel	85	1	44120121	44120122
14' Corral Panel	98	2	44120141	44120142
16' Corral Panel	110	2	44120161	44120162
4' x 7' Arch Gate	54	-	44120181	44120182
10' Ent. Panel w/ 4' Gate	91	-	44120201	44120202
12' Ent. Panel w/ 4' Gate	103	-	44120221	44120222

**NOTE:** ALL CORRAL PANELS ARE 4" LESS THAN LISTED LENGTH TO ALLOW PROPER CLEARANCE AND INSTALLATION.

# Utility Corral Panels



Our most popular corral panels to fit your lifestyle.

## Horse Country 18/20 Gauge Panel Corral Panel - 64" Tall

*Behlen Country's Best Value for Equine Owners!*

AVAILABLE COLORS:  GRAY  GREEN



- Designed specifically for horse owners
- Taller and heavier than our standard promo panel
- Our unique J-leg design has a small contact point with ground to prevent unwanted panel movement
- 14 gauge heavy duty smooth formed brace for maximum strength and durability
- Pin hookups:
  - ▶ Are easy to use
  - ▶ Reduce space between panels
  - ▶ Are usable on uneven ground
  - ▶ Allow 3 or 4 way connections for pens
- Chain hookups are simple and easy to attach
- Long-lasting UV resistant powder coat finish

HORSE COUNTRY CORRAL PANEL - PIN CONNECTION				
DESCRIPTION	LBS	VERT. BRACES	GRAY ITEM NO.	GREEN ITEM NO.
10' Corral Panel	55	1	44144107	44144102
12' Corral Panel	66	2	44144127	44144122
16' Corral Panel	84	3	44144167	44144162
6' x 9' Arch Gate	60	-	44144017	44144012
10' Ent. Panel w/6' Arch Gate	78	-	44144027	44144022
12' Ent. Panel w/6' Arch Gate	84	-	44144037	44144032

HORSE COUNTRY CORRAL PANEL - CHAIN CONNECTION				
DESCRIPTION	LBS	VERT. BRACES	GRAY ITEM NO.	GREEN ITEM NO.
10' Corral Panel	54	1	44146107	44146102
12' Corral Panel	65	2	44146127	44146122
16' Corral Panel	83	3	44146167	44146162
6' x 9' Arch Gate	59	-	44146017	44146012
10' Entrance Panel w/6' x 7' Arch Gate	77	-	44146027	44146022
12' Entrance Panel w/6' x 7' Arch Gate	83	-	44146037	44146032

**NOTE:** ALL CORRAL PANELS ARE 4" LESS THAN LISTED LENGTH TO ALLOW PROPER CLEARANCE AND INSTALLATION.





AVAILABLE COLORS: ● RED ● GREEN ● GRAY

DESCRIPTION	LBS.	VERT. BRACES	RED ITEM NO.	GREEN ITEM NO.	GRAY ITEM NO.
10' Corral Panel	42	1	44121101	44121102	44121107
12' Corral Panel	48	1	44121121	44121122	44121127
16' Corral Panel	63	2	44121161	44121162	44121167
4' x 8' Arch Gate	41	-	44121181	44121182	44121187
6' x 9' Arch Gate	58	-	44121011	44121012	44121017
12' Ent. Panel w/ 6' Gate	77	-	44121031	44121032	44121037

**NOTE:** ALL CORRAL PANELS ARE 4" LESS THAN LISTED LENGTH TO ALLOW PROPER CLEARANCE AND INSTALLATION.

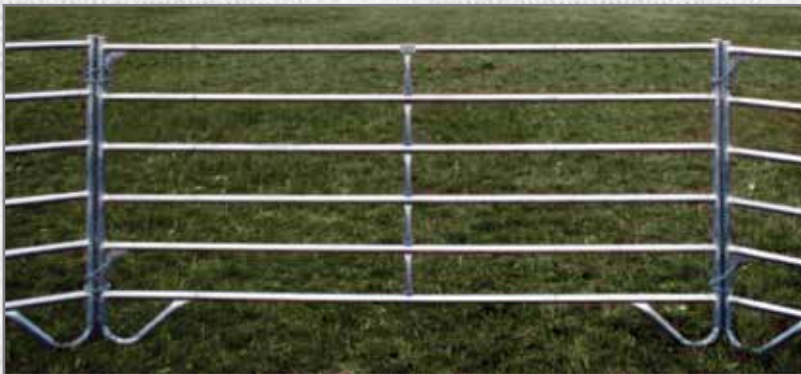

## 1 5/8" · Utility Panel Galvanized Corral Panel-64" Tall

AVAILABLE COLORS: ● GALVANIZED

PIN HOOK-UP			
DESCRIPTION	LBS.	VERT. BRACES	ITEM NO.
12' Corral Panel	55	1	44142128
6' x 9' Arch Gate	61	-	44142018
12' Entrance Panel w/ 6' Gate	79	-	44142038

CHAIN HOOK-UP			
DESCRIPTION	LBS.	VERT. BRACES	ITEM NO.
10' Corral Panel	47	1	44127108
12' Corral Panel	54	1	44127128
6' x 9' Arch Gate	59	-	44127028
12' Entrance Panel w/ 6' Gate	78	-	44127038

**NOTE:** ALL CORRAL PANELS ARE 4" LESS THAN LISTED LENGTH TO ALLOW PROPER CLEARANCE AND INSTALLATION..

- Combines lower cost with great features
- Great value in a corral panel, portable and easy to hook up on uneven ground
- Pin hookups:
  - ▶ Are easy to use
  - ▶ Reduce space between panels
  - ▶ Are usable on uneven ground
  - ▶ Allow 3 or 4 way connections for pens
- 18 gauge J-legs have a small contact point with ground to prevent unwanted panel movement
- 6 Rails
- Entrance panel has 7' tall arch
- Long-lasting UV resistant powder coat paint

- Economically priced panels feature corrosion resistant 1 5/8" galvanized tubing
- Pin hookups:
  - ▶ Are easy to use
  - ▶ Reduce space between panels
  - ▶ Are usable on uneven ground
  - ▶ Allow 3 or 4 way connections for pens
- Chain hookups are simple and easy to attach
- Optional butterfly clamps are available for a more solid and secure connection
- Our unique J-leg design has a small contact point with ground to prevent unwanted panel movement
- One piece vertical tube brace is formed and welded for maximum strength and stability
- 6 Rails
- Entrance panel has 7' tall arch



# Corral

## Kidding Pen Panels



Our most popular corral panels to fit your lifestyle.

### Kidding Pen

- Easy assembly for portability
- Several sizes of panels adapt to many different situations
- Ideal for confinement at shows and fairs
- Simple drop pin connections
- Finished with premium gray powder coat paint



Complete Kidding Pen

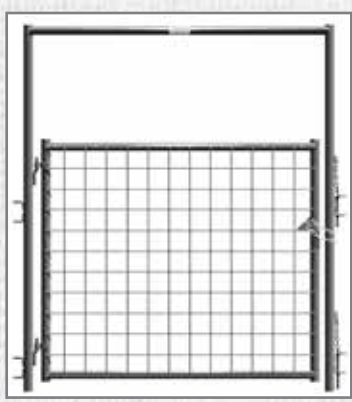

A.

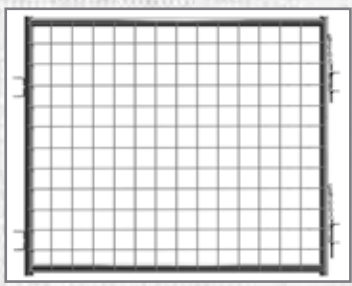

B.

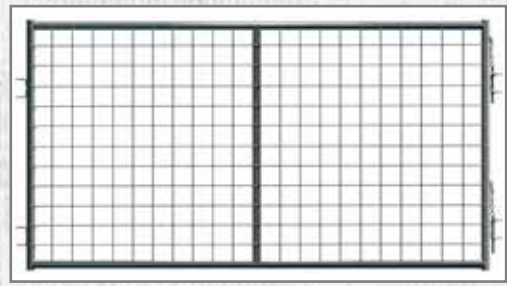

C.

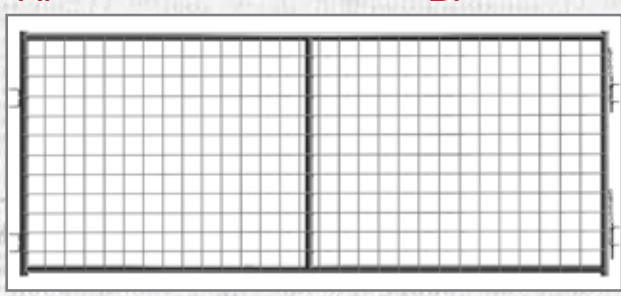

D.

DESCRIPTION	L/H	LBS	ITEM NO.
A. 5' Kidding Pen Gate Panel	5' x 4'	47	74123017
B. 5' Kidding Pen Panel	5' x 4'	29	74123057
C. 8' Kidding Pen Panel	8' x 4'	48	74123087
D. 10' Kidding Pen Panel	10' x 4'	52	74123107



# Corral Panel Accessories

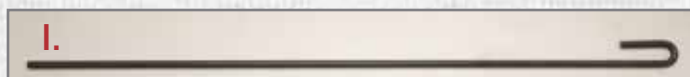
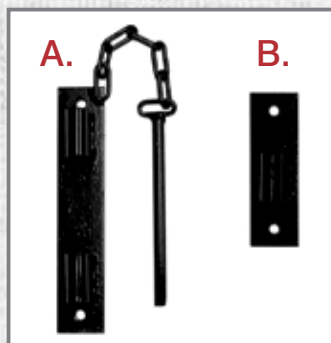

## A. & B. Corral to Wall Panel Hook-up

- Allows corral panels to be attached to a flat wall

## C. Galvanized Butterfly Clamps for 1-5/8" tubing

- Galvanized clamps add more stability and strength to corral panels with standard chain hookups

## D. Painted Butterfly Clamps for 1-5/8" tubing

- Galvanized clamps add more stability and strength to corral panels with standard chain hookups

## E. Galvanized Butterfly Clamps for 2" tubing

- Galvanized clamps add more stability and strength to corral panels with standard chain hookups

## F. Painted Butterfly Clamps for 2" tubing

- Galvanized clamps add more stability and strength to corral panels with standard chain hookups

## G. & H. Chain Hardware Package

- Used to fasten panels with chains
- Bolt and nut included

## I. Corral Adaptor Rod

- Used as a drop pin for hooking uncommon pin hookup corral panels together
- Heavy 9/16" diameter rod will take rugged abuse

### SHIPPING NOTE:

THERE IS A MINIMUM DOLLAR AMOUNT FOR ALL UPS SHIPPING ORDERS. PLEASE CONTACT US BY PHONE AT (800) 447-2751 FOR MORE INFORMATION. OR VISIT US AT [WWW.BEHLENCOUNTRY.COM](http://WWW.BEHLENCOUNTRY.COM)

DESCRIPTION	LBS.	SHIP UPS	ITEM NO.
<b>A. Corral to Wall Panel Hookup (Male)</b>	2	✓	44110407
<b>B. Corral to Wall Panel Hookup (Female)</b>	2	✓	44110417
<b>C. Galvanized Butterfly Clamps (2 Pair) for 1<sup>5</sup>/<sub>8</sub>" Tubing</b>	2	✓	38900069
<b>D. Painted Butterfly Clamps (2 Pair) for 1<sup>5</sup>/<sub>8</sub>" Tubing</b>	2	✓	38900067
<b>E. Galvanized Butterfly Clamps (2 Pair) for 2" Tubing</b>	2	✓	44900069
<b>F. Painted Butterfly Clamps (2 Pair) for 2" Tubing</b>	2	✓	44900067
<b>G. Chain Hardware Package (1 Chain)</b>	2	✓	44900100
<b>H. Chain Hardware Package (2 Chains)</b>	4	✓	44900090
<b>I. Corral Adapter Rod (51")</b>	4	✓	44110309

Behlen Country galvanized fence panels have over 3 times the zinc protection of other brands.

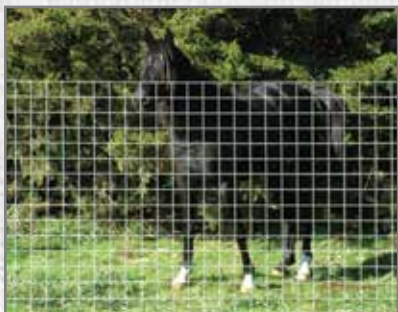

## Hot-Dipped Galvanized Fence Panels

- All panels are **hot-dip galvanized after welding** so all weld spots are completely covered, eliminating rust and corrosion at all “shear” points and joints.
- Nearly 2 lbs of zinc dramatically increases fence life, eliminates rust and reduces rod separation
- Hot-dipped galvanized delivers more than 3 times the protection of pre-galvanized rod.
- Available in a wide range of sizes for various applications.

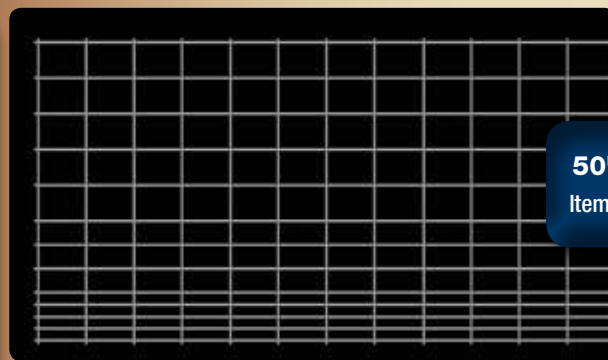
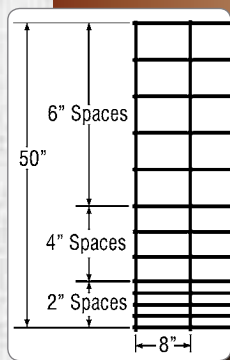

**50" Combo**  
Item # 33150999

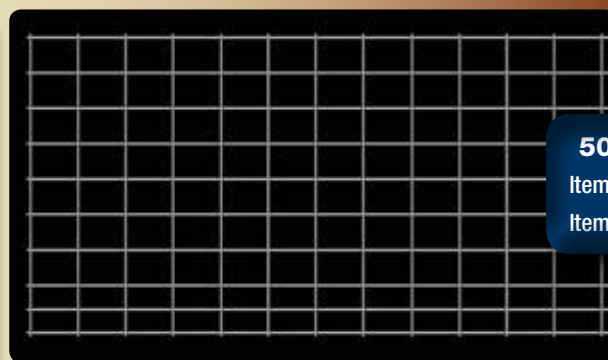
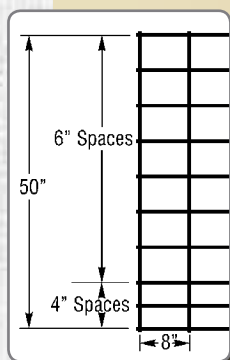

**50" Cattle**  
Item # 33150739  
Item # 33150699

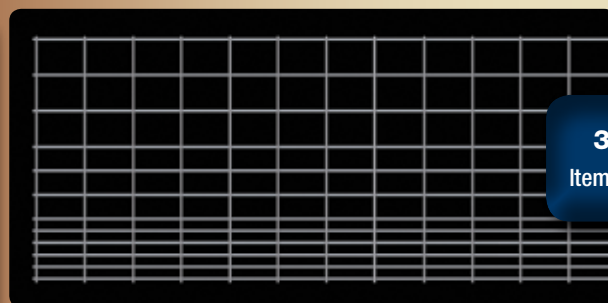
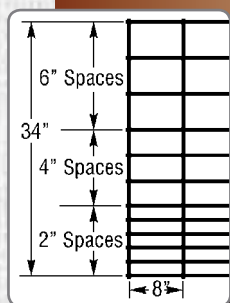

**34" Hog**  
Item # 33150979

DESCRIPTION	H/L	BUNDLE QTY.	NO. OF LINE WIRES	LBS	ITEM NO.
Combination 5 ga.	50" x 16'	50	13	35	33150999
Cattle 5 ga.	50" x 16'	50	10	29	33150739
Cattle 1/4" dia.	50" x 16'	50	10	44	33150699
Hog 5 ga.	34" x 16'	50	11	29	33150979



# anel

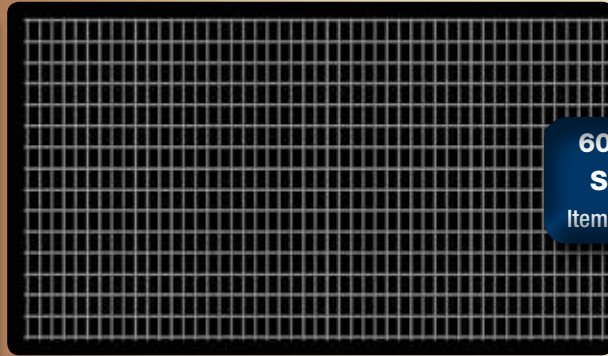
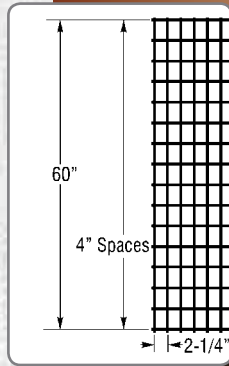

**60" Horse Security**  
Item # 33150759

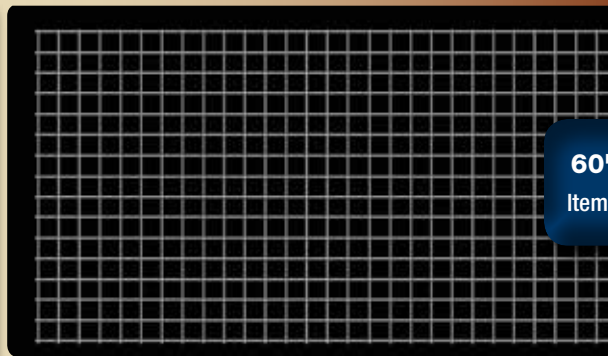
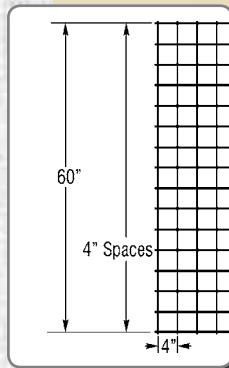

**60" Hi-Five**  
Item # 33150219

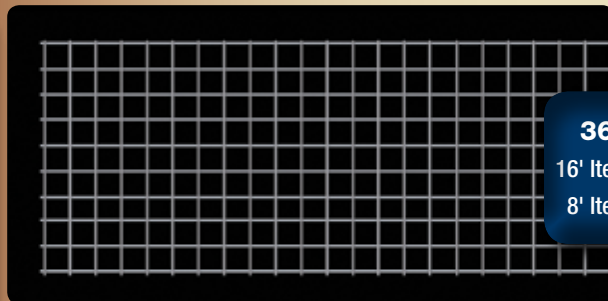
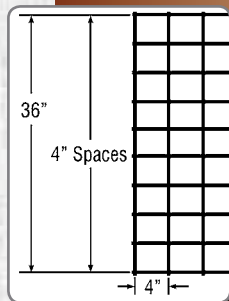

**36" Hi-Five**  
16' Item # 33150789  
8' Item # 33151029

DESCRIPTION	H/L	BUNDLE QTY.	NO. OF LINE WIRES	LBS	ITEM NO.
Horse/Security 6 ga.	60" x 16'	20	16	71	33150759
Hi-Five 5 ga.	60" x 16'	20	16	59	33150219
Hi-Five 5 ga.	36" x 16'	25	10	36	33150789
Hi-Five 5 ga.	36" x 8'	25	10	18	33151029

# Stalls

## Modular Horse Stalls

Premium-quality features and construction.

### Modular Horse Stalls

- **Powder Coated Panels** are finished with full baked premium powder coated polyester paint
- **Premium Hot-Dipped Galvanized Panels** are hot-dipped galvanized after fabrication for the ultimate in corrosion resistance and long life



Powder Coated Stall Pictured (Wood Customer Supplied)



Reversible latches allow stall to be easily configured as right or left entrance



Feed Door Latch



## Powder Coated Modular Horse Stalls

DESCRIPTION	L / H	LBS	ITEM NO.
10' Front Panel w/Door	10' x 7'	203	76110267
10' Stall Panel w/Bars	10' x 7'	138	76110277
10' Solid Panel	10' x 7'	117	76110247
12' Front Panel w/Door	12' x 7'	225	76110287
12' Stall Panel w/Bars	12' x 7'	162	76110297
12' Solid Panel	12' x 7'	137	76110257
12' Solid Front Panel w/ Door	12' x 7'	210	76110727

## Premium Hot-Dipped Galvanized Horse Stalls

DESCRIPTION	L / H	LBS	ITEM NO.
10' Front Panel w/Door	10' x 7'	205	76110269
10' Stall Panel w/Bars	10' x 7'	140	76110279
10' Solid Panel	10' x 7'	120	76110249
12' Front Panel w/Door	12' x 7'	228	76110289
12' Stall Panel w/Bars	12' x 7'	165	76110299
12' Solid Panel	12' x 7'	140	76110259
12' Solid Front Panel w/ Door	12' x 7'	212	76110729

## Stall Features

- Affordable, easy-to-set-up modular system allows for various row configurations
- Heavy 14 gauge, 2" round tube framing is used for extra strength and stability
- ½" solid vertical rods spaced 3" apart allow for better ventilation and viewing
- Each reversible stall front comes with a 4' left-hand rolling door and 2' feeder door
- Feeder door swings out easily and is low enough to allow even a child to use†
- Main door rollers on top allow the door to glide easily with minimal effort
- Optional Corner Feeders can be attached for feeding from outside the stall
- Lower 4' of stall can be filled with 2" (customer supplied) lumber (Comes with a chart that explains how to cut the wood. Designed to accept any 2" planed lumber...2" X 6", 2" X 8", etc.)

### \*SHIPPING NOTES:

THERE IS A MINIMUM DOLLAR AMOUNT FOR ALL UPS SHIPPING ORDERS. PLEASE CONTACT US BY PHONE AT (800) 447-2751, FOR MORE INFORMATION.

**FOR QUANTITIES OF MORE THAN THIRTY (30) STALLS, PLEASE CALL FOR LEAD TIME.**

### †NOTE:

FEED DOOR NOT TO BE USED AS A BREEZEWAY OPENING. DO NOT LEAVE FEED DOOR OPEN AND UNATTENDED.

## Connectors

DESCRIPTION	LBS	SHIP UPS*	ITEM NO.
A. Wall (Pair)	2	✓	76110317
B. 2-Way (Pair)	3	✓	76110327
C. 3-Way (Pair)	5	✓	76110337
D. 4-Way (Pair)	6	✓	76110347

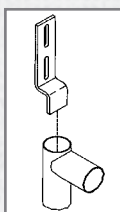

Top Wall Connector

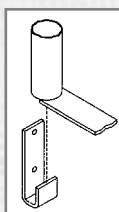

Bottom Wall Connector

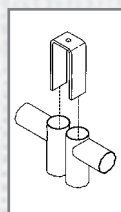

2-Way Connector

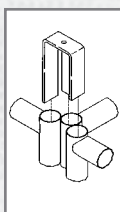

3-Way Connector

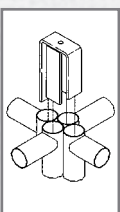

4-Way Connector



A.



B.



C.



D.



# Shelters

## Modular Shelter Kits

Engineered to be strong and versatile.

### Thirteen prepackaged kits integrate different collections of these great components:

- XT Corral Panels
- Stall Panels
- 12' Open Support Brace
- Shelter Packages
- Roof Connectors
- Can be added to as your needs change
- Considered a "portable shelter" (can be built in most areas without a building permit, check your local regulations)
- Includes 2" butterfly clamps (gray or galvanized)
- Each stall corner and each connection between corral panels requires a pair of connectors; XT panels come with chain hookups; however, butterfly clamps make a more sturdy connection
- Corner and Center Foot Pads keep corral panels from sinking
- Provides a 40-psf roof snow load, 90-mph wind load, when properly installed with 29 gauge or heavier roof sheeting



**AVAILABLE COLORS:** ● GRAY ○ HOT-DIPPED GALVANIZED

**IMPORTANT NOTE:** The Behlen Country Shelter System will work only with the Behlen Country 12' XT Corral Panels and Behlen Country 12' Stalls. Any substitution with other equipment may not work and will void all warranties. Behlen does not provide roof sheeting, ridge caps, roof screws or wood.

**SHIPPING NOTES:** There is a minimum dollar amount for all UPS Shipping Orders. Please contact us by phone at (800) 447-2751, for more information.

**NOTE:** Powder Coated panels are standard. Kits can be itemized to include Hot-Dipped Galvanized panels.



### Kit No. 1 Item No. 76078367

One 12' x 12' corral with roof framing package and an open front.

This kit includes the following:	Item No.
3) 12' XT Corral Panels	44131127
1) 12' Open Support Brace	76110697
1) Shelter Framing Package	76110678

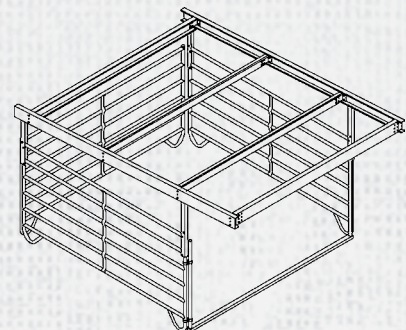



## Kit No. 2 Item No. 76078357

One 12' x 12' corral with shelter framing package and an entrance panel front.

This kit includes the following:	Item No.
3) 12' XT Corral Panels	44131127
1) 12' XT Entrance Panel	44131037
1) Shelter Framing Package	76110678
1) Horse Gate Latch	44112207

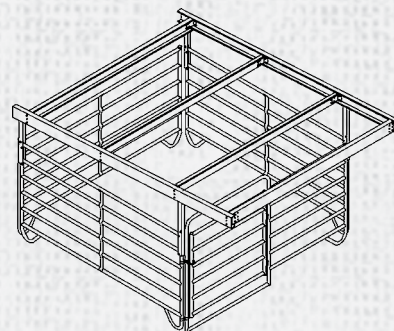

## Kit No. 3 Item No. 76078387

One 12' x 12' Behlen Country stall with shelter framing package and an open front.

This kit includes the following:	Item No.
3) 12' Solid Stall Sides	76110257
1) 12' Open Support Brace	76110697
1) Shelter Framing Package	76110678

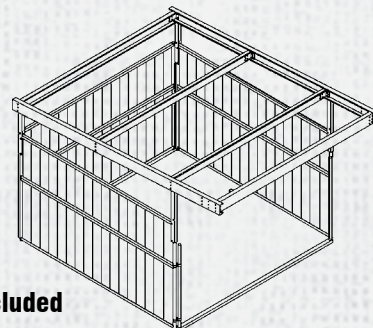

Wood **NOT** Included

## Kit No. 4 Item No. 76078377

One 12' x 12' Behlen Country stall with shelter framing package, solid sides and front with sliding door and feed door.

This kit includes the following:	Item No.
3) 12' Solid Stall Sides	76110257
1) 12' Stall Front	76110287
1) Shelter Framing Package	76110678

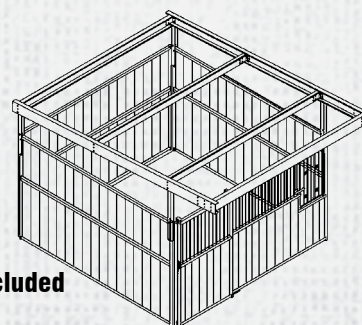

Wood **NOT** Included

## Kit No. 5 Item No. 76078477

Two 12' x 12' corrals side by side, with corral panel divider, open fronts, shelter framing package and add-on shelter package.

This kit includes the following:	Item No.
5) 12' XT Corral Panels	44131127
2) 12' Open Support Braces	76110697
1) Shelter Framing Package	76110678
1) Add-on Shelter Package	76110708

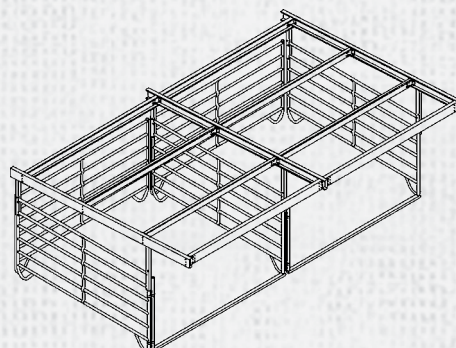

## Kit No. 6 Item No. 76078467

Two 12' x 12' Behlen Country stalls, side by side with solid panels, corral panel divider, open fronts, shelter framing package and add-on shelter package.

This kit includes the following:	Item No.
4) 12' Solid Stall Panels	76110257
1) 12' XT Corral Panel	44131127
2) 12' Open Support Braces	76110697
1) Shelter Framing Package	76110678
1) Add-on Shelter Package	76110708

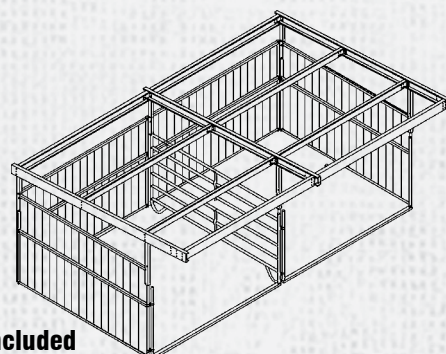

Wood **NOT** Included



## Kit No. 7 Item No. 76078407

Two 12' x 12' corrals with entrance panel fronts, and a 12' wide covered breezeway.

This kit includes the following:	Item No.
6) 12' XT Corral Panels	44131127
2) 12' XT Entrance Panel	44131037
2) Shelter Framing Package	76110678
2) 6' Center Roof Connectors	76110688
2) Horse Gate Latch	44112207

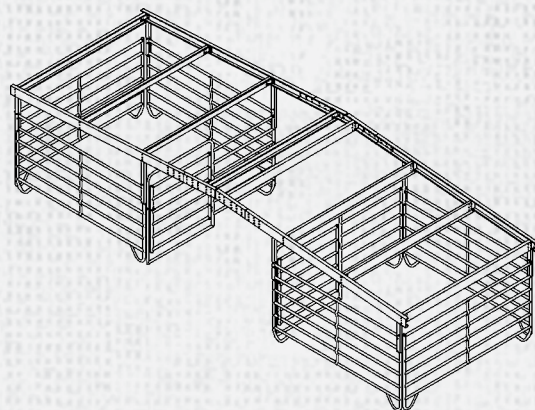

## Kit No. 8 Item No. 76078397

Two 12' x 12' Behlen Country stalls with solid sides and fronts with a sliding door and feed door, and a covered 12' wide breezeway.

This kit includes the following:	Item No.
6) 12' Solid Stall Panels	76110257
2) 12' Stall Fronts	76110287
2) Shelter Framing Packages	76110678
2) 6' Center Roof Connectors	76110688



**Wood NOT Included**

## Kit No. 9 Item No. 76078517

Two 12' x 12' corrals with entrance panel fronts and rears, a covered 12' breezeway and 12' x 24' runs.

This kit includes the following:	Item No.
14) 12' XT Corral Panels	44131127
4) 12' XT Entrance Panels	44131037
2) Shelter Framing Packages	76110678
2) 6' Center Roof Connectors	76110688
2) Horse Gate Latches (for fronts only)	44112207

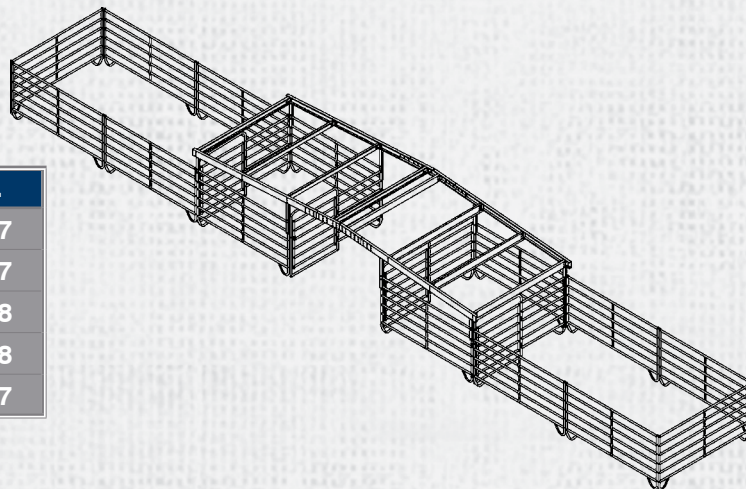

## Kit No. 10 Item No. 76078437

Four 12' x 12' corrals with entrance panel fronts and a covered 12' wide breezeway.

This kit includes the following:	Item No.
10) 12' XT Corral Panels	44131127
4) 12' XT Entrance Panels	44131037
2) Shelter Framing Packages	76110678
2) Add-on Shelter Framing	76110708
3) 6' Center Roof Connectors	76110688
4) Horse Gate Latches	44112207

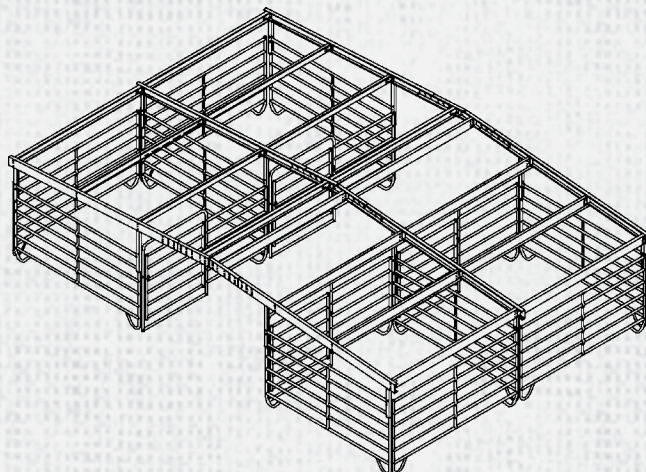





## Kit No. 11 Item No. 76078427

Four 12' x 12' Behlen Country stalls with solid sides and fronts with sliding door and feed door, and a covered 12' wide breezeway.

This kit includes the following:	Item No.
10) 12' Solid Stall Panels	76110257
4) 12' Stall Fronts	76110287
2) Shelter Framing Packages	76110678
2) Add-on Shelter Framing	76110708
3) 6' Center Roof Connectors	76110688

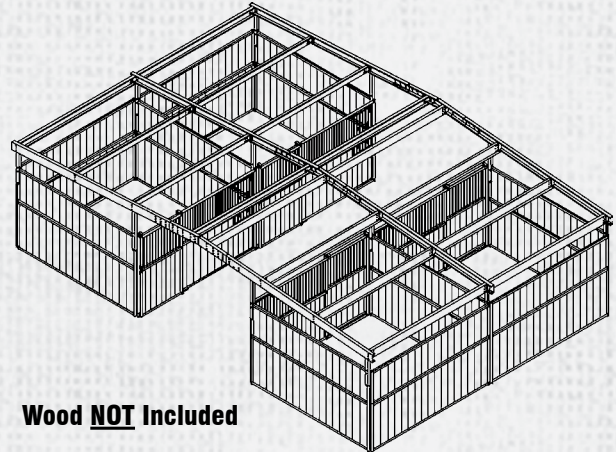

Wood **NOT** Included

## Kit No. 12 Item No. 76078557

Four 12' x 12' corrals with entrance panel fronts and rears, a covered 12' wide breezeway and 12' x 24' runs.

This kit includes the following:	Item No.
22) 12' XT Corral Panels	44131127
8) 12' XT Entrance Panels	44131037
2) Shelter Framing Packages	76110678
2) Add-on Shelter Packages	76110708
3) 6' Center Roof Connectors	76110688
4) Horse Gate Latches (for fronts only)	44112207

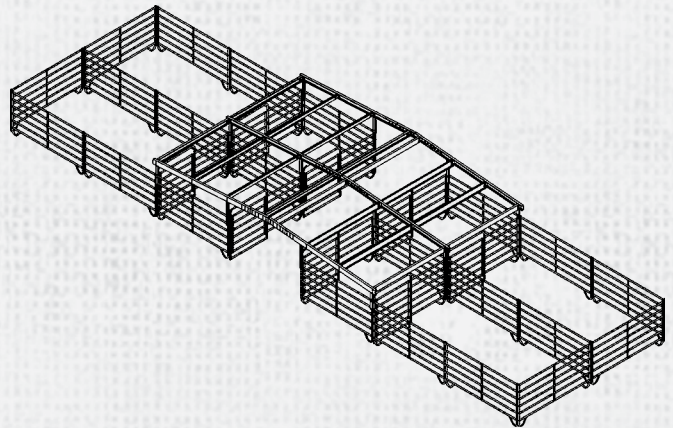

## Kit No. 13 Item No. 76078547

Four 12' x 12' Behlen Country stalls with solid sides, fronts with sliding door and feed door, and solid backs with sliding door, with a covered 12' breezeway, and 12' x 24' runs.

This kit includes the following:	Item No.
6) 12' Solid Stall Panels	76110257
4) 12' Stall Fronts w/door	76110287
4) 12' Solid Front Panel w/door	76110727
16) 12' XT Corral Panels	44131127
2) Shelter Framing Packages	76110678
2) Add-on Shelter Framing	76110708
3) 6' Center Roof Connectors	76110688

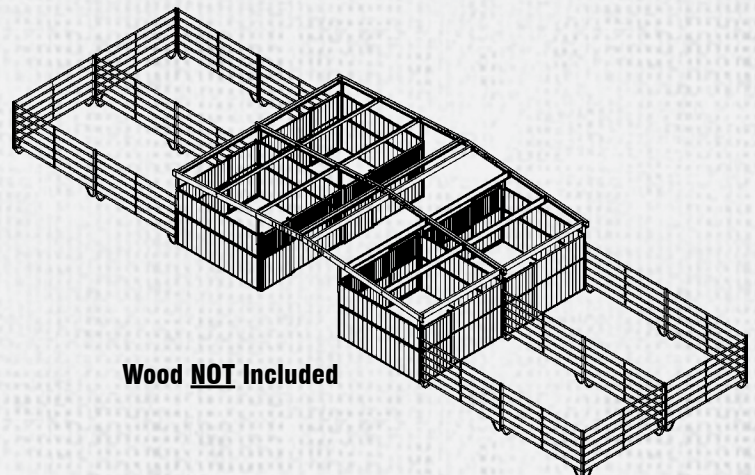

Wood **NOT** Included



## Modular Shelter Components

- NOTE: The Behlen Country shelter system will work **only with Behlen Country 12' XT Corral Panels and Behlen Country 12' Stalls Panels**. Any substitution with other equipment will not work and all warranties will be voided. Pictures showing installations complete with roof sheeting and wood sides are for reference only. **Behlen does not provide roof sheeting, ridge caps, roof screws or wood.** (Photos shown are variations of kits.)

Behlen Country previously made a 12' x 12' shelter. None of these 12' x 15' shelter parts will fit the older units.

### 12' XT Corral Panel

**Item No. 44131127 (gray)**

**Item No. 44131129 (galvanized)**

12' long, 6' high, 16/18 gauge 2" diameter tubing, chain hookups included.

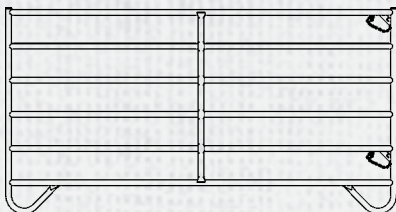

### 12' XT Entrance Panel

**Item No. 44131037 (gray)**

**Item No. 44131039 (galvanized)**

12' long, 6' high with 6' x 7' gate, used for front (or back, or both) of XT pen.

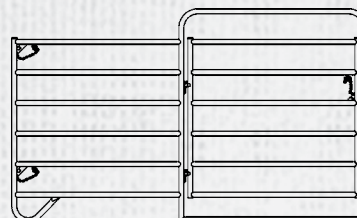

### Shelter Framing Package

**Item No. 76110678**

Basic roof framing for one pen or stall (12' x 15' w/front overhang), includes beams, purlins, shelter posts, butterfly clamps (to connect stall and XT Panels) and hardware.

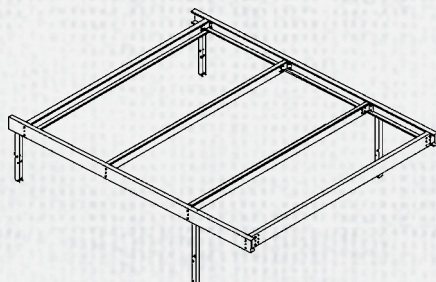

### Shelter Framing Package Add-on

**Item No. 76110708**

For second unit. Bolts to Shelter Framing Package, uses common beam. Includes beams, purlins, shelter posts, butterfly clamps (to connect stall and XT Panels) and hardware.

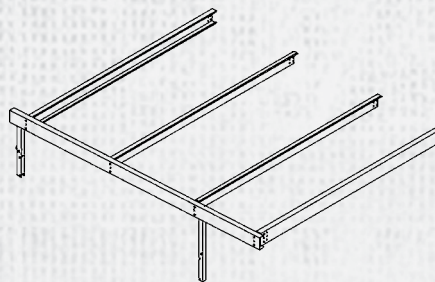

### 6' Center Connector

**Item No. 76110688**

This item makes a 6' piece that joins two shelters which are set up facing each other with a 12' breezeway in between. For a pair of shelters, you would buy two 6' Center Connectors. For each additional pair of stalls, you would buy one more center connector.

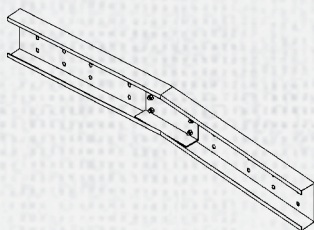

- NOTE: In a row of shelters, you would buy one Shelter Framing Package (76110678) and from that point on, you would buy all Add-ons (76110708). If you placed two

shelters **facing each other** with a breezeway between them you would have to buy two Shelter Framing Packages and two 6' Center Roof Connectors (76110708).

Each additional pair of facing stalls would require two more add-on framing packages and one more 6' center connector.

- NOTE: 6' Center Connectors are **not** used unless you are setting up pairs of shelters **facing each other with**



## 12' Open Support Brace

Item No. 76110697 (gray)

Item No. 76110699 (galvanized)

If you leave the front or back of a pen or stall open, you must use a 12' Open Support Brace to hold the sides securely. **When ordered as an individual component, 4 pair (2 pkgs.) of butterfly clamps must be ordered separately.**

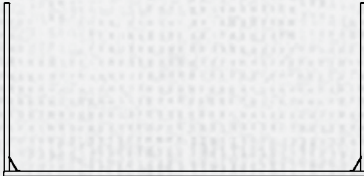

## 12' Stall Front

Item No. 76110287 (gray)

Item No. 76110289 (galvanized)

12' wide, 7' high, 4' wide sliding door, 2' wide feed door, (feeder optional), customer supplied filler on bottom, solid steel vertical bars on top.

Filler **NOT** Included

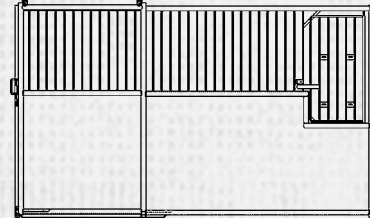

## 12' Stall Panel w/Bars

Item No. 76110297 (gray)

Item No. 76110299 (galvanized)

12' wide, 7' high, customer supplied filler on bottom, solid steel vertical bars on top.

Filler **NOT** Included

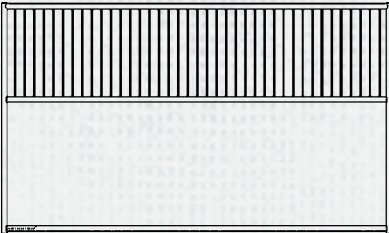

## 12' Stall Panel, Solid

Item No. 76110257 (gray)

Item No. 76110259 (galvanized)

12' wide, 7' high, metal frame with customer supplied filler on top and bottom.

Filler **NOT** Included

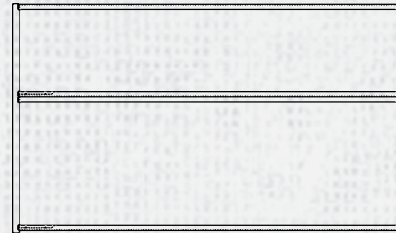

## 12' Solid Stall Front

Item No. 76110727 (gray)

Item No. 76110729 (galvanized)

12' wide, 7' high, 4' wide sliding door, customer supplied filler on top and bottom.

Filler **NOT** Included

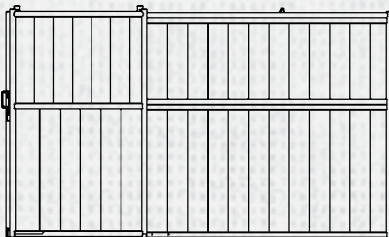

## Optional Horse Gate Latch

Item No. 44112207

Very simple, low-cost, bolt-on latch for XT Entrance Panel, or any other 1-5/8" or 2" Behlen gate.

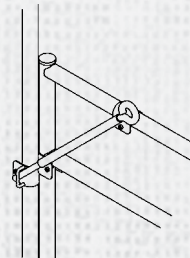



# Feeders

## Stall Feeders

Designed for horse safety and long life

### A. Wall Hay Rack

- 3/8" solid rod
- Finished with premium powder coat paint
- Depth from wall is 12"

### B. Corner Hay Rack

- 3/8" solid rod
- Finished with premium powder coat paint
- Depth from wall is 30"

### C. Galvanized Wall Feeder

- Provide a safe, durable and effective means of feeding both hay and grain from the same feeder
- Feeder is constructed of heavy galvanized steel
- Hay rack is fabricated from solid, galvanized rod
- All edges are rolled for enhanced animal safety
- Include a poly trough that is rust- and corrosion-free
- Come with mounting brackets to hang from a portable stall or attach directly to the wall

### D. Galvanized Corner Feeder

- Designed to provide a durable and efficient means of feeding both hay and grain from the same feeder without entering the stall
- All feeders have an enclosed back to prevent hay from falling out
- Feeder is constructed of heavy, galvanized steel
- Hay rack is fabricated from solid, galvanized rod
- All corners are rounded for enhanced animal safety
- Poly trough is rust- and corrosion-free
- **Intended for stalls with an already existing feed door**

### E. Swing out Corner Feeder

- For applications where a feed door is not already installed

### F. Poly Wall Feeder

- One-piece molded unit with smooth edges and a galvanized steel hay rack
- Can be mounted to wall or fence

### G. Poly Corner Feeder

- Made of poly with solid, galvanized rods for the hay rack
- One-piece molded unit with smooth, rounded edges for animal safety
- Designed for long life

### H. Utility Corner Feeder

- This large-capacity polyethylene feeder will not rust, warp, deteriorate in sunlight or split
- Resists chemicals, cribbing, mildew and puncture
- Has bottom drain for easy cleaning

### I. Poly Horse Grain Feeder

- Helps prevent throwing, pushing or spilling feed from the bowl
- Smooth, rounded edges prevent injury and allow animal to easily clean out all feed
- Corner or flat wall mounting

#### **\*SHIPPING NOTE:**

THERE IS A MINIMUM DOLLAR AMOUNT FOR ALL UPS SHIPPING ORDERS. PLEASE CONTACT US BY PHONE, AT (800) 447-2751, FOR MORE INFORMATION.





DESCRIPTION	L / W / D	DEPTH FROM WALL	LBS	SHIP UPS*	ITEM NO.
A. Wall Hay Rack	16" x 18" x 16"	12"	15	✓	76110867
B. Corner Hay Rack	32" x 13" x 11"	30" (from corner)	17	✓	76110907
C. Galvanized Wall Feeder	20" x 20" x 12"	-	36	✓	76110148
D. Galvanized Corner Feeder	27" x 21" x 24"	-	36	✓	76110128
E. Swing out Corner Feeder	20" x 20" x 12"	-	66	✓	76110138
F. Poly Wall Feeder	28" - x 24" x 18"	18"	18	✓	78110147
G. Poly Corner Feeder	35" x 21" x 21"	-	25	✓	78110067
H. Utility Corner Feeder	28" x 24" x 24"	30" (from corner)	15	✓	78110027
I. Poly Horse Grain Feeder	11" x 24" x 15"	10"	4	✓	78110037



# Bunks, Racks and Storage

## A. 5' Horse Bunk

- Strong yet portable
- Heavy duty galvanized steel construction
- Smooth, rounded corners
- Square ends allow bunks to be bolted together
- Optional Hay Rack available
- HFB10, HFB5, designed for horses, are taller



## B. 10' Horse Bunk

- Strong yet portable
- Heavy duty galvanized steel construction
- Smooth, rounded corners
- Square ends allow bunks to be bolted together
- One-piece molded poly trough
- Optional Hay Rack available
- HFB10, HFB5, designed for horses, are taller



## C. 5' Feed Bunk & Hay Rack

- Feed loose hay and grain at the same time
- Made from solid rod for extra durability
- Bolt directly to the galvanized feed bunk
- Comes complete with all hardware needed

## D. 10' Feed Bunk & Hay Rack

- Feed loose hay and grain at the same time
- Made from solid rod for extra durability
- Bolt directly to the galvanized feed bunk
- Comes complete with all hardware needed



## E. Poly Storage Container

- All poly construction will not corrode or rust
- Strong metal hinge for lid
- Holds 400 lbs. of feed
- Strong, yet lightweight
- Can be divided into two compartments, using 2 pieces of 1" thick lumber (not included)
- Ideal for feed, toys, firewood, recycling, etc.

## F. Grooming/Mounting Step

- Made of strong Rotomold poly
- Wide-base design is stable and the steps are slip-resistant
- Ideal extra step up when grooming or mounting a horse
- Available in green

DESCRIPTION	L / W / H	LBS	ITEM NO.
A. 5' Horse Bunk	60" x 40" x 36"	50	76121898
B. 10' Horse Bunk	120" x 42" x 35"	96	76110098
C. 5' Bunk w/Hay Rack	60" x 34" x 36"	100	76021888
D. 10' Bunk w/Hay Rack	120" x 34" x 36"	177	76021848
E. Poly Storage Container	24" x 25" x 34"	65	78110087
F. Grooming Step	24" x 24" x 17"	14	78110162



# Waterers

## A. 5-Gallon Stall Waterer

- No fire hazard
- Helps keep water warm in cool weather, and cool in warm weather
- Heavily insulated to prevent freezing (in an occupied stall)
- No electricity needed
- Five-gallon poly pail and float cover included
- Easy to clean out



## B. Bucket Holder

- Fastens to the wall using two 5/16" lag screws or bolts
- All-welded solid rod is galvanized for durability and long life

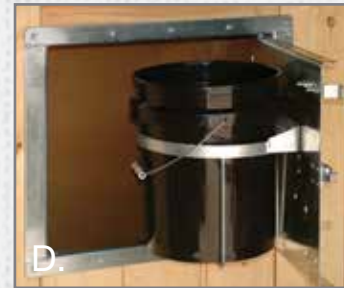

## C. Swing out Stall Waterer

- Provides a safe and efficient way to water animals without entering the stall
- Includes insulated unit and 5-gallon poly pail

## D. Swing out Bucket Holder

- Provides a safe and efficient way to water animals without entering the stall
- Swing out frame is constructed of heavy, galvanized steel with round, smooth edges and corners
- Bucket not included



## E. Automatic Stall Waterer with Heat (ASWH)

- Automatic fill valve ensures fresh water at all times
- Height adjustable from 40" to 18" by cutting off the bottom of the pedestal
- 100-watt super-efficient infrared heat pad
- Also available in a non-heated model

## F. Automatic Horse Waterer

- Available with or without infrared heat pad
- One-piece, heavily insulated waterer, poly design is rust and corrosion free
- Urethane in the walls provides over four times the insulation of competitors' models (tested to -20°F)
- Heat pads are totally isolated from the animal to prevent danger from shock
- Double-insulated design eliminates the possibility of stray voltage

DESCRIPTION	CAP. GAL.	L / W / D	DEPTH FROM WALL	LBS	SHIP UPS*	ITEM NO.
A. 5-Gallon Stall Waterer	5	16" x 18" x 16"	12"	10	✓	54140058S
B. Bucket Holder	5	13" x 11"	30" (from corner)	4	✓	76110038
C. Swing out Stall Waterer	5	20" x 20" x 12"	-	27	✓	54040038
D. Swing out Bucket Holder	5	20" x 20" x 12"	-	26	✓	76010048
E. Automatic Stall Waterer with Heat	-	12" x 14" x 41"	-	11	✓	54140358S
F. Automatic Horse Waterer	-	28" x 18" x 30"	-	39	-	54150018

**\*SHIPPING NOTE:** THERE IS A MINIMUM DOLLAR AMOUNT FOR ALL UPS SHIPPING ORDERS. PLEASE CONTACT US BY PHONE, AT (800) 447-2751, FOR MORE INFORMATION.



# Bale

## HAYSMART Bale Feeders



HAYSMART bale feeders keep the hay in the feeder and money in your pocket.

### HAYSMART Bale Feeder by Behlen Country

#### Benefits of the unique chain cone design:

- Increases hay utilization to more than 96% compared to 85% with other feeding methods
- Allows cattle to move the hay around, eating evenly through the toughest bale
- Suspends the hay off the ground at an ideal height

#### Superior strength and durability:

- 6' tall
- 18 tight feeding spaces
- 16 gauge heavy duty sheeting
- Grade 5 plated hardware
- 1/4" Grade 40 High Test chain
- Finished with green powder coat paint



#### Customer Gene Kinslow writes:

It is undoubtedly the best designed, heaviest round bale feeder we have ever had on the farm. Additionally, the 624 lb.. weight of feeder does not allow the cattle to move the feeder. Absolutely no hay slips out from underneath the HAYSMART feeder to be trampled like happens with a typical lightweight, traditional round bale feeder. This feeder is actually making us money. The HAYSMART bale feeder has saved Gene and many other customers a minimum of 20% of the hay fed.

DESCRIPTION	LBS.	ITEM NO.
HAYSMART Bale Feeder for Cattle	624	26120512





**The new Horse HAYSMART Bale Feeder keeps your hay in the feeder and money in your pocket.**

**Benefits of the unique chain cone design:**

- Increases hay utilization to more than 96% compared to 85% with other feeding methods
- Allows horses to move the hay around, eating evenly through the toughest bale
- Suspends the hay off the ground at an ideal height keeping it clean

**Poly Sheeted Bottom Features:**

- Superior horse safety; no sharp metal edges
- Twice as thick as any steel sheeted model on the market
- Easily replaceable for a lifetime of use

**Superior strength and durability:**

- Over 6' tall, 8' diameter
- 18 horse-safe feeding spaces
- 16 gauge heavy duty sheeting on top
- Grade 5 plated hardware
- ¼" Grade 40 high test chain
- Finished with gray powder coat paint



DESCRIPTION	LBS.	ITEM NO.
HAYSMART Bale Feeder for Horse	549	26120537



# Bale Feeders

Behlen Country offers a large selection of bale feeders.



## A. Economy Galvanized

- Economically Priced Feeder
- 1 5/8" Slant Bar Dividers
- Strong 16 GA Galvanized Frame



## B. Medium Duty

- Our Best Value Unsheeted Feeder
- 16 GA S-Bar Dividers Save More Hay
- Strong 16 GA Oval Tube Frame



## C. Sheeted Medium Duty

- Our Best Value Sheeted Feeder
- 16 GA S-Bar Dividers Save More Hay
- Strong 16 GA Oval Tube Frame



## D. Two Piece

- Strong, Dependable 2 Piece Design
- Heavy 1 5/8" Slant Bars
- Strong 14 GA Oval Tube Frame



## E. Two Piece

- Strong, Dependable 2 Piece Design
- Heavy 1 5/8" Slant Bars
- Strong 14 GA Oval Tube Frame



## F. Heavy Duty

- A Great Heavy Duty Feeder
- 16 GA S-Bar Dividers Save More Hay
- Heavy Duty 2" 16 GA Tube Frame



## G. Super Duty

- Our Strongest, Most Durable Feeder
- 16 GA S-Bar Dividers Save More Hay
- Extra Heavy Duty 2" 14 GA Frame



## H. Cattle HaySmart

- Saves more hay—Up to 96% utilization vs. 85% with other methods
- Keeps hay suspended off the ground keeping it cleaner and drier
- Easily one of the heaviest round bale feeders available



## I. V Bar

- Maximize Feeding with Bales Sized Up to 4' x 8'
- 16 GA Heavy Duty Sheeting
- Rugged 14 & 16 GA Tubing





### J. Horse

- Horse Safe Bale Feeder
- Horse Safe 16 GA Dividers
- Strong 16 GA Oval Tube Frame



### K. Hay Ring

- Horse Safe Bale Feeder
- Safe For Horned Cattle
- Strong 16 GA Oval Tube Frame



### L. Horse HaySmart

- Saves more hay—Up to 96% utilization vs. 85% with other methods
- Keeps hay suspended off the ground keeping it cleaner and drier
- An extremely heavy duty feeder that's still safe for horses

DESCRIPTION	COLOR	FEEDING SPACES	HT.	LBS.	ITEM NO.
A. Economy Galvanized Bale Feeder	Galv	9	44"	108	26100138
B. Medium Duty Bale Feeder	Green	12	45"	120	26100512
C. Sheeted Medium Duty Bale Feeder	Green	12	45"	156	26100522
D. Two Piece Bale Feeder	Green	15	46"	181	26100312
E. Two Piece Bale Feeder	Red	15	46"	181	26100311
F. Heavy Duty Bale Feeder	Green	15	52"	200	26100552
G. Super Duty Bale Feeder	Red	15	52"	228	26100181
H. Cattle HaySmart Bale Feeder	Green	18	72"	624	26120512
I. V Bar Bale Feeder	Green	16	56.5"	518	26000302
J. Horse Bale Feeder	Gray	9	50"	162	26121157
K. Hay Ring Bale Feeder	Gray	-	34"	138	26121027
L. Horse HaySmart Bale Feeder	Gray	18	72"	549	26120537
M. Century Bale Feeder	Black	6	46"	100	3018500



### M. Century

- Long life Polyethylene Pipe Design
- 7 Year Warranty
- Must Be Ordered in Quantities of 10



# Bale

## V Bar Hay Feeder



The Behlen Country V Bar Hay Feeder is built to handle your BIG bales!

### V Bar Hay Feeder

- Increased longevity of feeder with the unique V Bar design
- Maximize feeding with bales sized up to 4' x 8'
- Cattle consume hay more consistently with V Bars centering the bale
- 16 ga. heavy-duty sheeting
- Rugged 14 & 16 ga. tubing
- 56 1/2" tall
- Finished with our premium powder coat paint
- Individual panels available

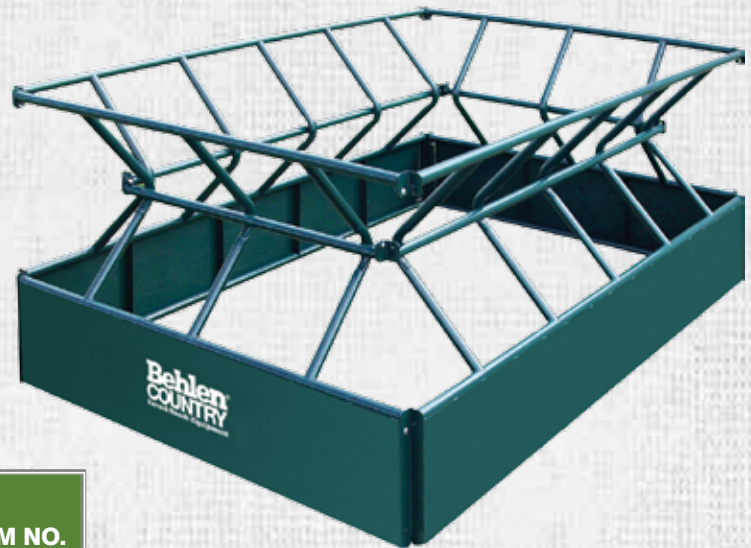

DESCRIPTION	WIDTH OF FEED SPACE OPENING	FEEDING SPACES	LBS.	ITEM NO.
V Bar 6' x 10' Hay Feeder	24"	16	518	26000302







## A. Hay Feeder Panels

- Great for feeding hay in-line or from a stack
- Can be connected together or used alone
- Designed to withstand abuse from the toughest animals
- “S-Bar” design saves hay and helps keep calves out of feeders
- Made from heavy 14 ga., 2" dia. steel tubing
- Painted with premium powder coat finish to ensure long life against sun fade, corrosion and weathering

## B. Calf Pass Panel

- Versatile way to keep larger animals out of smaller animal feed areas
- Manufactured with 2" (16 ga.) heavy-gauge steel
- Versatile chain connectors allow lockup to any post or panel
- The galvanized cross bar is infinitely adjustable for any size calf
- Provides 8 spaces with a width of 15" per space and a maximum height of 46½"
- Panels are finished with our premium powder coat paint



DESCRIPTION	WIDTH OF FEED SPACE OPENING	NUMBER OF FEEDING SPACES	LBS.	ITEM NO.
<b>A. Hay Feeder Panels</b>				
6' Feeder Panel	16 ¾"	4	83	26178062
8' Feeder Panel	14 ¼"	6	103	26178082
10' Feeder Panel	16"	7	123	26178102
12' Feeder Panel	15"	9	139	26178122
16' Feeder Panel	15"	12	185	26178162
<b>B. 12' Calf Pass Panel</b>		8	108	40168012



# Feed Bunks

## A. Galvanized Feed Bunk

- Heavy duty galvanized steel construction
- One-piece molded poly trough
- Smooth, rounded corners
- Square ends that allow bunks to be bolted together



## B. Painted Feed Bunk

- Heavy duty construction
- One-piece molded poly trough
- Smooth, rounded corners
- Square ends allow bunks to be bolted together
- Premium powder coat paint



## C. Standard 11' Feed Bunk

- Heavy duty, 16 ga. tubular frame
- Tough one-piece poly feed trough eliminates corrosion
- Smooth, all-welded design helps prevent injuries
- Five sturdy 2" straps support the trough
- Square ends that allow bunks to be bolted together
- Finished with our premium powder coat paint. Available in red or green.



## D. Poly Feed Bunk

- Rotomold of extra thick, FDA-approved, food-grade polyethylene that is easy to clean and corrosion-free
- Ribbed, double-wall construction
- Deep, rounded feed troughs and drain openings prevent spoiled feed
- Pluggable drain openings allow use as a water tank
- Tested to -20° F
- So tough they come with a two-year warranty against livestock damage
- Available in 5' and 10' lengths

DESCRIPTION	L / W / H	FEED CAP. CU. FT.	DEPTH	LBS	ITEM NO.
A. 10' Galvanized Feed Bunk	120"/34"/19"	12.5	10"	85	22121798
A1. 5' Galvanized Feed Bunk	60"/34"/19"	6	10"	44	22121758
A2. 5' Galvanized Sheep Bunk	60"/32"/14"	6	10"	40	22121748
B. 10' Painted Feed Bunk	120"/34"/19"	12.5	10"	75	22121791
C. Standard 11' Bunk -Red	130"/34"/20"	17.5	10"	112	22121941
C. Standard 11' Bunk -Green	130"/34"/20"	17.5	10"	112	22121942
D. 10' Poly Feed Bunk	120"/31"/20"	20	15"	110	22122217
D. 5' Poly Feed Bunk	60"/31"/20"	10	15"	50	22122207
Drain Plug for Poly Bunks	-	-	-	-	1328286
Liner for 5' Bunk	-	-	-	11	2958301
Liner for 10' Bunk	-	-	-	22	2958302
Liner for 11' Bunk	-	-	-	23	2958360



## E. 5' Horse Feed Bunk

- Heavy duty galvanized steel construction
- Smooth, rounded corners
- Square ends that allow bunks to be bolted together
- Optional Hay Rack available
- Designed taller for horses
- Strong yet portable



## F. 10' Horse Feed Bunk

- Same great benefits as the 5' bunk only longer (see bullets above)



## G. Galvanized Hay Racks

- Allows you to feed loose hay and grain at the same time
- Made from solid 3/8" rod for extra durability
- Bolt directly to the galvanized feed bunk
- Comes complete with all hardware needed



## H. Complete Feed Bunk & Hay Rack

- Available in 5' and 10'

## I. All Metal Feed Bunk

- Extra Large Capacity
- Length 10'
- Width 40"
- Trough Depth 14"
- Overall Height 24"
- Bunk Capacity 30 cu. ft.
- 14 g Gauge Trough
- 244 lbs.



DESCRIPTION	L / W / H	FEED CAP.	DEPTH	LBS	ITEM NO.
E. 5' Horse Feed Bunk	60"/40"/35"	6	10"	50	76121898
F. 10' Horse Feed Bunk	120"/42"/35"	12.5	10"	96	76110098
G. Hay Rack for 5' Bunk	60"/34"/36"	12	-	56	76021908
G. Hay Rack for 10' Bunk	120"/34"/36"	24	-	86	22121818
H. Complete 5' Horse Feed Bunk & Hay Rack	60"/40"/71"	18	-	106	76021888
H1. Complete 10' Horse Feed Bunk & Hay Rack	120"/42"/71"	36.5	-	182	76021848
I. All Metal Feed Bunk	120"/40"/24"	30	14"	244	22130101



# Mineral Feeders

## A. Super Bull Mineral Feeder

- Large 40" diameter base and 17" tall
- 4.6 cu. ft. capacity easily holds up to 250 lbs. of salt or mineral (block or loose)
- Lynch pin retainer for fast flap removal and easy filling
- Large base with 3 anchor points eliminates tipping
- High quality UV protected polyethylene resists breakage, even at -20° F.



## B. & C. Heavy Duty Poly Bull Feeders

- Tough enough for bulls, easy enough for small animals
- Self-closing rubber cover keeps out rain, snow and dirt
- Poly and rubber materials are corrosion-proof and will withstand cold temperatures
- Available with three or four compartments to hold mineral



## D. Super Wind Vane Feeder

- It starts at the bottom...the hot dipped galvanized bottom gives you the most corrosive resistant base in the industry against salt, mud, manure, etc.
- Heavy-duty 3/8" tow loops allow the unit to be pulled from location to location for rotational grazing with a four-wheeler or tractor
- Heavy-duty sealed, plated bearing offers years of maintenance-free service and reliable spinning action
- Two compartment poly feeder hood will not corrode



## E. Wind Vane Feeder

- Tough, functional and economical
- All-poly rotating head protects mineral
- 1.9 cu. ft. poly tub, large 48" dia. base ring is solid 3/4" steel for extra long life

DESCRIPTION	L / W / H	FEED CAP.	LBS	ITEM NO.
A. Super Bull Mineral Feeder	40" x 17"	4.6 cu. ft.	54	28140212
B. 3 Block Mineral Feeder	40" x 8"	3.5 cu. ft.	42	28140197
Replacement Lid for 3 Block Mineral Feeder			20	3018098
C. 4 Block Mineral Feeder	48" x 7"	5 cu. ft.	56	28140207
Replacement Lid for 4 Block Mineral Feeder	-	-	23	3018097
D. Super Wind Vane Feeder	48" x 53" x 57"	3 cu. ft.	81	28120002
E. Wind Vane Feeder	48" x 58"	1.9 cu. ft.	59	28040307
Face Fly Attachment for D.	-	-	7	28110080





# Hog Feeders & Troughs

## A. Economy Hog Feeder

- P1 and P2 models come fully assembled
- Galvanized steel available in one and two-door
- Trough feed adjustment control
- Ideal for youth projects
- Not recommended for confinement installations



A1.



A2.

## B. Feed Troughs

- Heavy 14 gauge steel troughs great for feeding or watering
- Mig welded to assure leak-proof construction
- Painted with premium powder coat paint



B.

## C. "V" Trough Feeder

- Trough is 14" from ground
- Drain holes help prevent spoilage
- Top bar keeps animals out of feeder
- Available in 4' and 8' lengths



C1.



C2.

DESCRIPTION	L / W / H	FEED CAP.	SHIP UPS*	LBS	ITEM NO.
A1. Economy Hog Feeder 1 Door - P1	12" x 22" x 28"	2.00 cu. ft.	✓	27	70120058
A2. Economy Hog Feeder 2 Door - P2	24" x 22" x 28"	2.88 cu. ft.	✓	45	70120048
B. Feed Trough	2' x 18" x 7"	-	✓	16	56121027
B. Feed Trough	4' x 18" x 7"	-	✓	27	56121047
C1. 4' "V" Trough Feeder	48" x 32" x 14"	-	-	42	74023337
C2. 8' "V" Trough Feeder	96" x 32" x 14"	-	-	63	74023327

**\*SHIPPING NOTE:** there is a minimum dollar amount for all ups shipping orders. Now order parts that ship via ups online at [www.parts.behlenmfg.com](http://www.parts.behlenmfg.com) or call (800) 447-2751, for more information.



# Calf Creep Feeders

## Calf Creep Feeders

- One-piece poly feed hopper will not corrode or rust
- All steel parts are galvanized for long life and durability
- Keeps cows out and allows calves to eat
- Molded-in side deflectors provide protection from rainwater
- Tall side height keeps larger animals from reaching into feed area
- Molded trough brace promotes animal safety in eating area
- Runners for hopper face side-to-side to allow feeder to be moved easily
- Easy to assemble - long drop rods for quick assembly
- UV stabilizers help prevent sun damage
- The galvanized cross bar is infinitely adjustable for any size calf
- Tested to -20°F



DESCRIPTION	STALL SPACING	H x L x W OF STALL	H x W OF FEEDER	FEED/LBS CAPACITY	CALF CAPACITY	LBS.	ITEM NO.
Calf Creep Feeder - 750 lbs	15.5"	47" x 52" x 88"	34" x 54.5"	750	25	275	24121768
Calf Creep Feeder - 1200 lbs	15.5"	47" x 54" x 88"	34" x 87.375"	1200	40	370	24121778
Grill Pkg Only -(fits both feeders)	-	-	-	-	-	123	24121518
Hopper Only - 750 lbs	-	-	34" x 87.375"	750	-	184	24121538
Hopper Only - 1200 lbs	-	-	34" x 87.375"	1200	-	230	24121548



# Specialty

## Calf Hutch, Anchor Stakes, Post Driver

### A. Calf Hutch

- Protect calves and small animals from weather extremes
- Opaque material prevents overheating in summer temperatures
- Rear vent openings

### B. Anchor Stakes

- Can be used for a variety of applications, including fence corner anchors, tie-downs, guying trees and shrubs, tethering pets; or for tent stakes
- Available in four different sizes
- Insert pipe or rod through the eye as a handle to screw the anchor into the ground

### C. Post Driver

- Constructed of heavy pipe
- Capped with a special plug that balances the unit
- Works with any standard t-post or u-post



A.



B.



C.

POST DRIVER	L/W/H	LBS	ITEM NO.
A. Calf Hutch	79" x 54" x 46"	70	68110018

ANCHOR STAKES	LB. PULL	LBS	ITEM NO.	ORDER IN MULTIPLES
B. 15" long, 4" plate w/ 3/8" rod	3080	8	35150031	12
B. 30" long, 4" plate w/ 3/8" rod	4180	15	35150051	12
B. 40" long, 6" plate w 1/2" rod	5940	33	35150071	12
B. 48" long, 6" plate w 1/2" rod	13200	77	35150131	6

POST DRIVER	LBS	ITEM NO.
C. Steel Post Driver	16	35150212



# Tanks & Galvanized Stock Tanks

## Galvanized Tanks

- Ideal for all your livestock watering needs
- Built to endure the most severe farm and ranch conditions
- Corrosion resistant, heavy zinc coating assures long life
- Rigid sidewalls have both ribs and corrugations for maximum strength
- Heavy galvanized tank bottoms (20 ga.)
- Heavy, reinforced steel tube rolled into the top lip for added strength and durability

### NOTES:

- Tank sizes are nominal and will be slightly less than stated size.
- For lower freight costs, two or three tanks of the same size will be nested, requiring the inner tanks to be undersized.
- Waterers not available in round tanks.



## Round-End Tanks

NOMINAL W/H/L IN FEET	APPROX. CAPACITY GALLONS	CROSS BRAC-ES	LBS.	MODEL NO.	ITEM NO.
2 x 2 x 3	71	-	35	RE223	50130018
*2 x 2 x 4	103	-	44	RE224	50130028
*2 x 2 x 5	134	-	52	RE225	50130038
*2 x 2 x 6	169	1	64	RE226	50130048
**2 x 2 x 8	224	1	81	RE228	50130058
**3 x 2 x 6	231	1	84	RE326	50130008
**3 x 2 x 8	294	1	94	RE328	50130088
**3 x 2 x 10	377	2	120	RE3210	50130098

NOTE: Tanks identified with \* ship in lots of 3 (A, B, & C sizes) Quantities other than 3 may be subject to a surcharge. \*\*Nested in lots of 2 (A & B sizes).

## Round Tanks

NOMINAL SIZE IN FEET	APPROX. CAPACITY GALLONS	LBS.	MODEL NO.	ITEM NO.
<i>Round tanks are 2 feet high</i>				
3 Diameter	85	40	R32	50130118
4 Diameter	165	55	R42	50130128
5 Diameter	265	78	R52	50130138
*6 Diameter	389	102	R62	50130148
7 Diameter	535	126	R72	50130158
*8 Diameter	706	153	R82	50130168
*10 Diameter	1117	213	R102	50130188

NOTE: Tanks identified with \* ship in lots of 3 (A, B, & C sizes). Quantities other than 3 may be subject to a surcharge. All other sizes are nested in lots of 2 (A & B sizes).



# Waterers

## Shallow Galvanized Tanks

- Just right for sheep and other small animals
- Built with high-quality premium sheet metal in the sidewalls
- Heavy reinforced steel tube rolled into the top lip for added strength and durability
- Corrosion resistant, heavy zinc coating assures long life
- The bottoms are made of heavy galvanized steel (20 ga.)
- Easily tipped to drain



NOMINAL W/H/L IN FEET	APPROX. CAPACITY GALLONS	LBS.	MODEL NO.	ITEM NO.
**2 x 1 x 4	44	44	<b>ST214</b>	<b>50130198</b>
**2 x 1 x 6	70	64	<b>ST216</b>	<b>50130218</b>

NOTE: \*\*Nested in lots of 2 (A & B sizes).

## Galvanized Waterer Tanks

*Two drinking levels service both large and small animals.*

- The poly waterer has a large opening to make it easier for animals to drink
- The waterer box and float are molded from tough, food-grade polyethylene for cleanliness and long-life
- The built-in float guard protects the valve and float mechanism
- Valves adjust easily for proper water level
- The rubber gasket seal prevents leaking

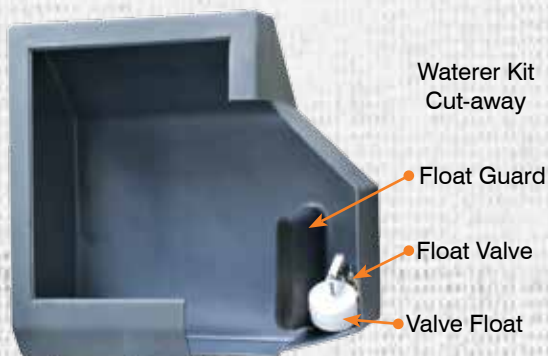

NOMINAL SIZE W/H/L IN FEET	APPROX. CAPACITY GALLONS	LBS.	MODEL NO.	ITEM NO.
2 x 2 x 4 w/Water Position 2	100	59	<b>RE224RW1</b>	<b>501300281</b>
2 x 2 x 6 w/Water Position 2	165	78	<b>RE226W1</b>	<b>501300481</b>
GALVANIZED WATERER ACCESSORIES				
ACCESSORY	SHIP UPS*	LBS.	MODEL NO.	ITEM NO.
Waterer Kit	✓	15	<b>WK</b>	<b>50131018</b>
Float Valve	✓	1	<b>W320A</b>	<b>56010188</b>
Valve Float	✓	1	<b>VP</b>	<b>50300938</b>



# Tanks &

## Poly Stock Tanks

### Poly Stock Tanks

- Durable seamless design resists breakage.
- All round-end tanks have an extra heavy duty, molded rim and an extra-deep sidewall rib design for additional strength.
- Round tanks have a “formed open” rim.
- Heavy duty, molded-in aluminum drain fitting and 1¼" poly drain plug ensure a long-life. (PRE214 & PRE216 have no drain plugs because they are easy to tip.)
- FDA food-grade approved poly, tested to -20° F, corrosion-free, impact resistant and recyclable.
- Premium UV Protection assures long life and resistance to color fade in outdoor use.
- All poly tanks have a **THREE-YEAR WARRANTY.**

#### \*SHIPPING NOTE:

There is a minimum dollar amount for all UPS shipping orders. Now order parts that ship via UPS online at [www.parts.behlenmfg.com](http://www.parts.behlenmfg.com) or call (800) 447-2751 for more information.

#### ^COLOR NOTE:

Special colors available.



### Round Tanks

NOMINAL SIZE	APPROX. CAP. GAL.	LBS.	SHIP UPS*	COLOR <sup>A</sup>	MODEL NO.	ITEM NO.
<b>Round tanks are 2 feet high**</b>						
A. 6' Diameter	350	62	-	Blue	PR62	52113068
B. 8' Diameter	625	92	-	Blue	PR82	52113088
C. 9' Diameter **(this tank is 2'-4" high)	1000	112	-	Blue	PR928	52113098

### Round-End Tanks

NOMINAL SIZE W/H/L IN FEET	APPROX. CAP. GAL.	LBS.	SHIP UPS*	COLOR <sup>A</sup>	MODEL NO.	ITEM NO.
D. 2 x 1 x 4 Sheep Tank	50	16	-	Granite Tan	PRE214	52110047GT
E. 2 x 1 x 6 Sheep Tank	70	27	-	Granite Tan	PRE216	52110067GT
F. 2 x 2 x 3	65	23	-	Granite Tan	PRE223	52112037GT
G. 2 x 2 x 4	100	30	-	Granite Tan	PRE224	52112017GT
H. 2 x 2 x 5	125	39	-	Granite Tan	PRE225	52112057GT
I. 2 x 2 x 6	150	49	-	Granite Tan	PRE226	52112027GT
J. 3 x 2 x 8	300	77	-	Blue	PRE328	52112187



# Waterers



## K. Automatic Fill Valve (GTV)

- Three gallons per minute. The Automatic Fill Valve (GTV) works with all model tanks. Includes an automatic, non-siphon valve to adjust the water level with the turn of a knob



K.

## L. Deluxe Fun Pool

- One-piece construction, will not rust, rot or corrode
- Wide, heavy duty rim has no sharp edges
- UV inhibitors prevent sun damage
- Built-in fun slide, two built in seats, four built in cup holders
- Large, 1 1/4" hole for fast draining



M.

## M. Water Boy w/GTV Valve

- Quickly and easily converts an ordinary garden hose into an automatic animal waterer
- Ideal for watering animals on a temporary or permanent basis
- Includes an automatic, non-siphon valve (GTV)
- Adjust the water level by the turn of a knob
- Premium UV Protection assures long life and resistance to color fade in outdoor use
- Molded-in carrying handles and a recessed hose inlet



N.

## N. Poly Round 26" Tub

- Perfect alternative to a 5 gallon bucket for watering or feeding livestock
- Premium UV Protection assures long life and resistance to color fade in outdoor use

DESCRIPTION	APPROX. CAP. GAL.	LBS.	SHIP UPS*	COLOR	MODEL NO.	ITEM NO.
K. Automatic Fill Valve (GTV)	-	4	✓	White	GTV	52120048
L. Deluxe Fun Pool 80" x 90" /24" deep	500	90	-	Blue	DFP	52113018
M. Water Boy Tank w/GTV Valve 30" dia. x 15" deep	30	17	✓	Blue	PR3016	52114138
N. Poly Round 26" dia. x 9" deep	14	10	✓	Black	PR269	28107908



# Tanks &

## Energy-Free Waterers

### How They Work

Heavy foam insulation keeps water at the perfect temperature, regardless of conditions. Ground water enters the unit between the temperatures of 48°F and 56°F, where it remains until the waterer is opened by the animal. As the animal drinks, new water enters through the automatic valve and mixes with the water already in the waterer, so it is constantly replenished and prevented from freezing. The water in the waterer is kept in the dark, which prevents algae growth.

When the waterer is not in use, an optional Shut-Off Valve Kit prevents water from entering and drains the waterline to prevent freeze up.

Energy-Free Waterer float balls push down effortlessly, requiring half the pressure of competitors' float balls, so even calves, sheep and other small animals can drink easily.

### Energy-Free Waterers

- Built-in hold downs
- New, non-siphoning BL water valve, which features:
  - Fast, consistent fill
  - Units have a non-siphoning, easy maintenance water valve
  - Use with pressure lines from 0-55 p.s.i.
  - Additional pressure regulator required for pressures above 55 p.s.i.
- Removable drain plugs and accessible covers
- Fully assembled, ready to install
- 5-year limited warranty on the body and a 1-year limited warranty on valves and controls
- To ensure proper operation in cold weather, it is recommended that each unit be installed with the Poly Earth Tube (purchased separately)



### A. & B Super 2 or 4-Hole Cattle Waterer

- Designed for heavy cattle use in extremely cold temperatures
- Tested at -20°F for 48 hours without freezing with no animals drinking
- Rim design helps keep float balls free of ice buildup
- Extra-thick 4" urethane insulation
- Removable top for hot weather operation
- Easy access for installation and maintenance

### C. 4-Hole Cattle Waterer

### D. 2-Hole Cattle Waterer

### E. & F. Poly Earth Tubes 18" & 24"

- NEW heavily insulated design
- Provides the protection needed to keep the riser pipe from freezing below the ground even in the coldest weather
- Sections connect with screws



### G. Shut-Off Valve Kit

- Hydrant style drain back feature protects waterer from freezing when not in use

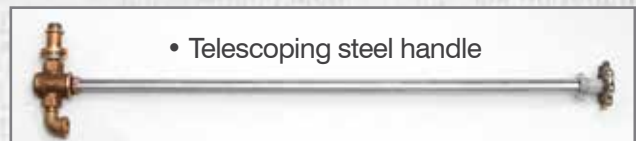



# Waterers



DESCRIPTION	L/W/H	MIN. ANIMAL CAP.	ANIMAL CAP. GAL.	WATER CAP. GAL.	LBS	SHIP UPS*	MODEL NO.	ITEM NO.
A. Super 2-Hole	44" x 27" x 28"	20	160 Beef/70 Dairy	40	100	-	SF-2C	54110068S
B. Super 4-Hole	44" x 44" x 28"	30	260 Beef/100 Dairy	80	160	-	SF-4C	54110078
C. 4-Hole	36" x 36" x 23"	30	260 Beef/100 Dairy	35	90	-	EF-4C	54110048
D. 2-Hole	36" x 21" x 23"	20	160 Beef/70 Dairy	20	67	✓	EF-2C	54110028
OPTIONAL EQUIPMENT								
DESCRIPTION	DIMENSION		LBS	SHIP UPS*	MODEL NO.	ITEM NO.		
E. 18" Poly Earth Tube	12" O.D. x 18"		7.5	✓	ET-18	54130038		
F. 24" Poly Earth Tube	12" O.D. x 24"		10	✓	ET-24	54130048		
G. Shut-off Valve Kit	-		6	✓	EFSK	54130168		

**\*SHIPPING NOTE:**

There is a minimum dollar amount for all UPS shipping orders. Now order parts that ship via UPS online at [www.parts.behlenmfg.com](http://www.parts.behlenmfg.com) or call (800) 447-2751 for more information.



# Tanks &

## Electric & Insulated Waterers

### Electric & Insulated Waterers

- One-piece, heavily insulated waterer, poly design is rust and corrosion free
- Thick styrofoam floor keeps the frost line below the waterer
- Urethane in the walls provides over four times the insulation of competitors' models (tested to -20° F)
- Low-wattage, infrared heat pad directly under the water trough (starts at approx. 42°F)
- Heat pads are totally isolated from the animal to prevent danger from shock
- Double-insulated design eliminates the possibility of stray voltage
- Units have a non-siphoning, easy maintenance water valve
- Additional pressure regulator required for pressures above 55 p.s.i.
- An optional low-pressure valve is available for special applications
- Built-in hold downs
- Removable drain plugs
- Easy access doors
- Fully assembled, ready to install



### A. Extreme Weather Poly Waterer

- Powerful 220 watt infrared heat pad heats the underside of the water basin
- Large, 8 gallon capacity
- 5 year warranty on the body
- Assembled for the customer
- Large access panel
- Molded-in hold downs
- Latched float cover for easy maintenance
- Extra thick insulation keeps the cold out and reduces energy costs



### B. Companion/Horse Waterer

- Made especially for horses, exotic pets or small farm animals.
- Rounded corners for safety
- Large access panel for hookup and maintenance
- Molded-in hold downs
- Thick insulation
- Deep 8" bowl holds 5.5 gallons
- The AHW30 is electric and uses a 75-watt super-efficient infrared heating pad, which is thermostatically controlled

#### \*SHIPPING NOTE:

There is a minimum dollar amount for all UPS shipping orders. Now order parts that ship via UPS online at [www.behlencountry.com](http://www.behlencountry.com) or call (800) 447-2751 for more information.

**\*\*Oversize UPS charges apply.**



# Waterers



C. Calf/Sheep/Horse Waterer

D. Cattle/Horse Waterer

E. Extra-Capacity Cattle Waterer

F. Automatic Stall Waterer

- Automatic fill valve ensures fresh water at all times
- Rounded corners for safety
- Height adjustable from 40" to 18" by cutting off the bottom of the pedestal
- 100-watt super-efficient infrared heat pad
- Sealed thermostat

DESCRIPTION	L/W/H	HT. OF TROUGH	ANIMAL CAP.	WATTS	AMPS	LBS	SHIP UPS*	MODEL NO.	ITEM NO.
A. Extreme Weather	30" x 20" x 32"	24"	100	220	2.1	58	-	AHW100	54150158
B. Horse/Companion w/Heat	21" x 22" x 23"	16"	Variable	75	.7	25	✓	AHW30	54150088
C. Calf/Sheep w/Heat	28" x 18" x 22"	16"	80	100	1	28	✓	AHW60	54150028
D. Cattle w/Heat	28" x 18" x 30"	24"	80	100	1	39	✓**	AHW80	54150018
E. Extra-Cap. Cattle w/Heat	34" x 29" x 30"	24"	250	250	2.3	63	-	AHW250	54150068
F. Automatic Stall Waterer w/ Heat	12" x 14" x 41"	Adjust.	1/Stall	100	1	11	✓	ASWH	54140358S
F. Automatic Stall Waterer	12" x 14" x 41"	Adjust.	1/Stall	-	-	10	✓	ASW	54140348S



# Tanks & Waterers

## Stock Tank Accessories

### Stock Tank Accessories

#### A. Top Mount Float Valve

- Can be used with either poly, steel or galvanized metal tanks

#### B. Float Valve Kit (Ball & Chain)

- Requires hole to be drilled in side of tank

#### C. 1 1/4" Bulkhead Fitting & Plug

- Complete repair kit for poly tanks with damaged 1" flange and plugs, or for adding more drains

#### D. 1" Poly Tank Plug

#### E. Washer for 1" Poly Tank Plug

#### F. Drain Plug Package for Poly

- 1-1/4" Poly Tank Plug and Washer
- 1/2" square drive

#### G. Tank Plug for Galvanized Tanks

- 3/8" square drive

#### H. Replacement Drain 1 3/4" Bulkhead Fitting & Plug

- Bulkhead fitting for adding accessories to steel and poly tanks

#### I. Sealant Caulk for Galvanized Tanks



A.



C.



B.



D., E.



F.



G.



H.



I.

DESCRIPTION	LBS.	SHIP UPS*	MODEL NO.	ITEM NO.
A. Top Mount Float Valve	3	✓	TMFV	3888133
B. Float Valve Kit (Ball & Chain)	7	✓	FVK	52120038
C. 1 1/4" Bulkhead Fitting & Plug	-	✓	BHF	52114108
D. 1" Poly Tank Plug	-	✓	TP1	2928062
E. Washer for 1" Poly Tank Plug	-	✓	W1	6882294
F. Drain Plug Package	-	✓	DPP	52300028S
G. Tank Plug for Galvanized Tanks	-	✓	TPGZ	2928077
H. 1 3/4" Replacement Drain for Galvanized Tanks	-	✓	RDBF	50130405
I. Sealant Caulk for Galvanized Tanks	-	✓	-	3288026



# Waterer Accessories



Above: BL Valve pictured with Pressure Restrictor



DESCRIPTION	LBS.	SHIP UPS*	MODEL NO.	ITEM NO.
A. BL Valve & Float Assembly for all Electric & Insulated Waterers	1	✓	BLV	3888244S
B. BL Valve (No Float)	1	✓	BL	3888245S
C. Pressure Restrictor for BL Valve (above)	1	✓		54300998
D. BL Float Assembly (No Valve)	1	✓	BLF	3888251S
E. Orifice Replacement Kit (3/4") for above BL Valve Assembly <i>-not pictured</i>	1	✓	BLHFK	54300968
F. Plunger and Seal Kit for above BL Valve	1	✓	BLSK	54300978
G. Low-Pressure Valve	1.5	✓	EFLPV	54130328
H. Low-Pressure Valve & Float	2	✓	EFLPVF	54130338
I. 10" Float Ball	8	✓	EFFB	54300088
J. Thermostat - New Style (for all heated waterers)	1	✓	-	3668011
K. 250-Watt Submersible Heater (fits in the AHW100)	3	✓	SH250	52120088
L. Kerrick Valve (for use in ASW-H)	1	✓	KV	2958378S
M. Heat Pad 75-Watt 10" x 14"	1	✓	-	2198172S
N. Heat Pad 100-Watt 10" x 19"	1	✓	-	2198160S
O. Heat Pad 250-Watt 20" x 25"	1	✓	-	2198162S
P. Heat Pad 220-Watt 20" x 22"	1	✓	-	2198175S
Q. Rubber Seal for Franklin Valve (pkg of 5)	1	✓	-	54300988
R. Drain Plug	1	✓	-	54300018

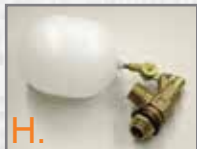

M., N., O., P.



Q.



R.

**\*SHIPPING NOTE:**

There is a minimum dollar amount for all UPS shipping orders. Now order parts that ship via UPS online at [www.parts.behlenmfg.com](http://www.parts.behlenmfg.com) or call (800) 447-2751 for more information.



# Cattle Eq

## Chutes & Headgates

### Don't Operate Without a Chute

If you keep a herd of 50 head or less, you might not think a squeeze chute is for you. Yes, you can work cattle with a headgate, or the help of a few loyal friends who rope. But there are lots of reasons why use of a squeeze chute should be on the top of your list. Your safety is at the top of that list. Herd health, and the related economic benefit it creates, is also an important payoff.

For example, Researchers at the University of Kentucky developed enterprise budgets for 50-cow herds with a \$5,000 investment in handling facilities that included a headgate and chute. The resulting increases in calving percentages and weaning weights, as well as lower death loss rates for both cows and calves, proved that the investment paid for itself in less than five years.

### Choosing the Right Chute

Before buying a squeeze chute, you need to answer a few questions about its intended use. Bovines come in all sizes, weights and attitudes, so a chute that works for one producer may not work for another.

Some squeeze chutes apply squeeze pressure from only one side, while others squeeze from both sides, forming a 'V' shape that helps balance and support the animal. Regardless of design, experts agree that the best squeeze chutes allow both sides to squeeze equally, thus keeping the animal balanced. The Canada Plan Service gives the following guidelines for the inside widths of the chute at the bottom of the V shape:

- Six inches for 250 to 400 pound calves.
- Eight inches for 600 to 800 pound animals.
- Twelve inches for cows and heavy feeders.
- Fourteen to sixteen inches for larger bulls.

Animal scientists with the Alabama Cooperative Extension service list four basic types of headgates: self-catching, scissors-stanchion, positive-control, and full-opening stanchion. Once again, you need to know what kind of animal you'll run through the chute. For example, self-catching gates don't work well with horned cattle. There are lots of options available:

- A door or space that allows injections to be given in an animal's neck is a necessity in order to avoid damaging expensive cuts of meat.
- A service door or palpation cage provides access to the rear of animals.
- Hydraulic squeeze chutes take some of the effort out of operation.

*Squeeze chutes put the squeeze on the animals, not the operator.*





# Equipment

## Silencer™

### Hydraulic Squeeze Chute

- The most innovative and technologically advanced chute in the cattle industry
- A patented noise reduction system of 130 contact points sheathed in oil based polyethylene to significantly reduce the noise level
- Full-opening head and tail door
- The headgate is wrapped in rubber to prevent shoulder damage to the animal
- Hydraulic head restraint (becomes half of the neck bars when used that way)
- Rubber louvers prevent animals from seeing humans to the side of chute
- Side exit available Left/Right/Both
- Neck bar Left/Right
- Hydraulic Lower Squeeze
- Dual additional neck access for precision vaccinating
- Choice of power units
- For animals from 350 lbs. on up
- Premium powder coat paint - Gray

### Heavy Duty Model

In addition to the standard features, the main frame has 4" x 2" x 3/16" rectangular tubing, 1/4" wall side-gates, 1/4" floor for increased life of chute, modular construction for superior maintenance, replaceable heavy-duty drop bars, 10 quick change re lube roller bearings - top connector and lower head door connector and 6 - 4 x 2 cylinders.

### Deluxe Ranch & Heavy Duty Extended Chutes

Silencer Extended model chutes are designed with a rear door for the operator to step in behind the animal for artificial insemination, semen checking, pregnancy checking, embryo transfer, etc.

**Other models and options, are available. Call 800-447-2751 for quotes.**

#### Additional Options

Heavy Duty and Commercial Pro, Extended Length, Palpation doors, Pivot Controls, Pivot Controls w/ Overhead Scales, Dual Controls, Neck Bars, Hydraulic Neck Extenders Left/Right/Middle, Dehorner Bar, Hydraulic Kick Bar, Yearling Side Gates-Both Sides, Brisket Bar, Rebar Floor, Platform Scales, Vertical/Horizontal Split Droppan, Leg Puller



### Chute Specifications

EQUIPMENT DETAIL	RANCH	HEAVY DUTY	EXTENDED
Height	93"	93"	93"
Head & Tailgate Height	67.5"	67.5"	67.5"
Inside Height	67.5"	67.5"	67.5"
Outside Length	100"	100"	130.5"
Inside Length	91"	91"	120.5"
Width (Door Open)	67"	67"	67"
Width (Door Closed)	59"	59"	59"

### Hydraulic Chutes & Accessories

DESCRIPTION	LBS.*	ITEM NO.
Deluxe Ranch Chute w/ Left-Hand Controls	2495	62175712
Heavy Duty Chute w/ Left-Hand Control	3095	62175802

\*Weights will vary per chute with options selected. Weight of chute with 5 h.P. Unit.



## HHD

### Hydraulic Squeeze Chute

#### Standard Features

- Heavy Duty Hydraulic Headgate, Tailgate & Squeeze for maximum flexibility
- 8' long to handle calves to the largest bulls
- Direct cylinder on headgate & tailgate for quick response and less bruising
- 5-hp single phase removable power unit for optimum power in all conditions
- All pivots have bronze bushings for smooth action and greater durability
- 1/4" floor plating
- Headgate and tailgate bushings 3 1/2"
- 12 gauge sheeting
- Frame tube 2 1/2" sq. x 3/16"
- Detachable Neck Extensions

#### Optional Features

- Rumber Floor
- Side Exit
- Hydraulic Neck Sweep
- Palpation Door
- Pivot Controls
- Louvers

Call 800-447-2751 for quotes.



#### Chute Specifications

EQUIPMENT DETAIL	DIMENSION
Overall Height	90"
Inside Height	65"
Overall Width	74"
Overall Floor Length	96"
Overall Length	106"
(Extended Model) Overall Floor Length	110"

#### Hydraulic Chutes & Accessories

DESCRIPTION	LBS.	ITEM NO.
Hydraulic Chute w/ Hydraulic Floor Adjustment	2800	62179012



# HMD

## Hydraulic Squeeze Chute

### Standard Features

- Dual voltage motor, pre-wired for 115V with plug, capable of 230V
- Full 8' long chute
- Hydraulic headgate, tailgate, squeeze, & optional live floor
- Bronze bushings on every joint
- Compatible with M1-V chute trailer for use anywhere
- Heavy M1-V drop bars and latches are standard
- Fully assembled from the factory, ready to use
- 1500 lb. capacity

### Optional Features

- Rumber Floor
- Side Exit
- Hydraulic Neck Sweep
- Palpation Door
- Pivot Controls
- Louvers

**Call 800-447-2751 for quotes.**



### Chute Specifications

EQUIPMENT DETAIL	DIMENSION
Overall Height	90"
Inside Height	65"
Overall Width	72"
Overall Floor Length	96"
Overall Length	104"
(Extended Model) Overall Floor Length	110"

### Hydraulic Chutes & Accessories

DESCRIPTION	LBS.	ITEM NO.
HMD Squeeze Chute w/Hydraulic Floor - 115V/230V	2100	62178912
HMD Squeeze Chute w/Hydraulic Floor Side, Exit and Neck Bender	2200	62178962
Trailer w/ Rims/ No rubber	320	62173692



## M1-V

### Squeeze Chute

- A user-friendly, heavy-duty chute designed for animal and operator safety.
- Best value in its class.
- Capable of handling the largest mature animals yet providing maximum adjust ability from 2500 lbs down to 300 lbs cattle.

### Standard Features

- Right-hand or left-hand control operation
- Dual side exits
- Choice of fully sheeted split tailgate or “Easy Action” vertical lift tailgate
- Dual neck access area for safe and easy vaccinations
- Double-side squeeze
- Dual side Drop-Down Side Bars
- Drop-down and detachable Sheeted Side Panels
- Double Bottom Floor adjusts from 8" - 29" (16 settings)
- HD850 Scale Brackets on every chute

### Optional Features

- Choice of 3 headgates
- M-Series Chute Trailer
- Palpation A.I. Cage



**M-Series Self-Catch Headgate & Vertical Lift Tailgate**

### Chute Specifications

EQUIPMENT DETAIL	DIMENSION
Overall Height	99"
Inside Height	69"
Inside Chute Length	96"
Overall Length w/ either Headgate, w/Vertical Tailgate	104"
Usable Inside Floor Width	23"

### Chutes & Accessories

DESCRIPTION	LBS.	ITEM NO.
M1-V Chute w/ Fully Sheeted Split Tailgate Mounted *Headgate not included	1245	62175892
M1-V Chute w/ Vertical Lift Tailgate Mounted *Headgate not included	1060	62175882
M-Series Chute Trailer (w/ rims, less rubber)	320	62173692

### Compatible Headgates

DESCRIPTION	LBS.	ITEM NO.
M-Series Self-Catch Headgate	292	60110132
M-Series Manual Headgate	226	60110012
M-Series Manual Headgate w/ Nek-Stenders®	265	60110022



Split Tailgate



Vertical Lift Tailgate



## MX-V

### Squeeze Chute

- Superior value yet economically priced.
- Breakthrough design is tough enough and big enough to handle a wide variety of animals.
- Designed with the safety of the operator and the animal in mind.

#### Standard Features

- Left-hand control operation
- Single side exit
- “Easy Action” vertical lift tailgate
- Double-side squeeze
- Double-side Drop-Down Side Bars
- Drop-down Sheeted Side Panels
- Double-side Bottom Floor adjusts from 7" - 17" (9 settings) to accommodate a wide variety of animals
- 1000 lbs capacity
- **Includes CL-5 Self-Catch Headgate**

#### Optional Features

- MX-V chute trailer
- Palpation A.I. Cage



#### Chute Specifications

EQUIPMENT DETAIL	DIMENSION
Height	76 7/8"
Length	97 5/8"
Width	39"

#### Chutes & Accessories

DESCRIPTION	LBS.	ITEM NO.
MX-V Chute, Incl. Vertical Lift Tailgate & Headgate	911	62175862
MX-V Chute Trailer	250	62173602
Adapter Kit, Crowd Alley to Chute (non-adjustable hookup) hooks directly to crowd alley	25	64171002
Adapter Kit, Corral Panel to Chute - hooks directly to chute	27	64171012
Chute to Crowd Alley Adapter (Replaces 1 ea. 64160422 or 64160612 arches when hooking sheeted or unsheeted systems directly to the chute.)	179	64160602

## Calf Table

Updated design for years of use. Locking tilt and reversible head gate make for flexible operation. This table is a must for branding, castrating and vaccinating calves up to 450 lbs.

#### Standard Features

- Reversible headgate & tilt release
- Lower access panel
- Heavy duty drop bars and ratcheting latches
- Fully assembled from the factory ready to use
- 2 Dally cleats for rear leg tie off
- Headrest for reduced stress included



NOTE: Calf Table Shown with Headgate

EQUIPMENT DETAIL	L/W/H	LBS.	ITEM NO.
Calf Table	65" x 46" x 62"	381	62176802
Calf Table Headgate	-	93	62176812



## Chute Trailers

### M-Series Chute Trailer

- Convenient, one-man loading and transporting of the M1-V and HMD chutes
- Chute can be raised and lowered with hand winch
- Allows easy positioning of chute to alleyway
- 2" Ball coupler
- Adjustable jack
- Includes rims, less tires



*Tires not included*

DESCRIPTION	LBS.	ITEM NO.
M-Series Chute Trailer (w/ rims, less tires)	320	62173692

### MXV Chute Trailer

- Provides convenient loading and transporting of the MX-V chute
- Hookup brackets (supplied) attach to pre-drilled holes on chute
- Uses 2" ball coupler
- Finished with our premium powder coated finish
- Includes rims, less tires



*Tires not included*

DESCRIPTION	LBS.	ITEM NO.
MXV Chute Trailer	250	62173602

## A.I. Cage

- Provides a safe, convenient access area behind the chute
- Sheeted double doors self-lock to block alley and keep you safe
- Allows quick access to the opposite working area
- Attaches to the rear of any Behlen Country Squeeze Chute
- Includes adapters to attach to Behlen Country Adjustable Crowd Alley, allowing the Crowd Alley to be adjustable when attached to the A.I. Cage
- A.I. Cage Transport Bracket is used when the A.I. Cage is being transported while attached to a chute; it provides the necessary support to keep the A.I. Cage from twisting or bending the frame of the chute



DESCRIPTION	L/W/H	LBS.	ITEM NO.
A.I. Cage	32.5" x 32.5" x 80"	195	62178422



## Heavy Duty Headgates

### A. M-Series Self-Catch Headgate

- Adjustable from both sides for a more precise fit and increased safety
- Attaches to any Behlen Country chute, right- or left-hand operation
- Adjusts to handle livestock from 300 lbs. and up
- Recommended for M1 & M1-V chutes
- Pins allow for quick adjustment of width opening



A.

### B. M-Series Manual Headgate

- Features the “Pos-o-lock” ratchet system, ensuring that cattle are caught safely and can’t escape
- Opening handle attaches parallel to the chute, out of the operator’s way, offering plenty of leverage to reduce operator fatigue
- Design of the handle allows it to swing from behind the animal, encouraging forward movement
- Attaches to any Behlen Country chute, operates either right-handed or left-handed
- Available with or without Nek-Stender® bars
- Recommended for M1 & M1-V chutes



B.



C.  
M-Series Manual Headgate w/ Nek-Stenders®

## Standard Duty Headgates

### D. CL-5 Utility Headgate

- Perfect for small herds
- Either manual or self-catch operation
- Yoke width adjusts from 4½" to 8"
- Left-hand or right-hand operation
- Mounts to alleyway or any of our Behlen Country chutes
- Recommended for alley headgate stand



D.



E.

DESCRIPTION	LBS.	ITEM NO.
A. M-Series Self-Catch Headgate	292	60110132
B. M-Series Manual Headgate	226	60110012
C. M-Series Manual Headgate w/ Nek-Stenders®	265	60110022
D. CL-5 Utility Headgate	235	60110202
E. Headgate Stand	128	46180242



## Tru-Test Indicators



- Tru-Test designs, manufactures, and markets the world's leading electronic livestock weighing systems
- When you choose Tru-Test from Behlen Country®, you receive the backing of a company that supports its products
- Tru-Test indicators and load-bars are backed by a two-year warranty that includes parts and labor
- All warranty work is done at the service center in Mineral Wells, Texas

### A. Ezi-Weigh5i

- Simple to use
- Largest weight display on the market
- High contrast display with LED backlight, making it viewable in all conditions
- Durable case to withstand the toughest environment
- Tru-Test's Superdamp™ III for speed and accuracy
- Compatible with all Tru-Test load bars and load sensors
- Auto zero function, ensuring any accumulated dirt is not weighed
- Fine mode for smaller weights

### B. ID5000

- Store up to 250 thousand records in 250 weighing sessions. For each animal you can record up to 3 IDs and 3 pieces of information (other than weight)
- Sort animals into uniform groups. Up to 5 groups can be created
- Quickly transfer information using your mobile and/or tablet device, USB flash drive or computer
- Flexible use with any Tru-Test loadbars and platforms
- Long battery life 10 hrs with backlight, 13 hours with backlight off

## Tru-Test Loadbars

### C. MP600 Loadbars

- Designed for use with a platform
- Can be easily transported from site to site
- For use on a firm, level surface
- Wt. cap. 4,400 lbs. - 23" long

### D. HD850 Loadbars

- Designed for permanent installation under Behlen Country M1 & M1-V Squeeze Chutes
- Their unique footing absorbs side loading force, preventing damage to scale
- Wt. cap. 6,600 lbs. - 34" long

### E. Ezi-Weigh5i System

- Total weighing capacity of 4400 lbs.
- Perfect product for basic weighing platform applications
- Includes all necessary power options and accessories
- Includes Ezi-Weigh indicator and MP600 Loadbars

DESCRIPTION	LBS.	ITEM NO.
A. Ezi-Weigh5i Indicator	2	3158092
B. ID5000 Indicator	4	3158091



DESCRIPTION	LBS.	ITEM NO.
C. MP600 Loadbars	240	3158069
D. HD850 Loadbars	76	3158070
E. Ezi-Weigh5i System	41	3158093

Call 800-447-2751 for quotes. Other indicators, loadbars, and platforms are available upon request.



# Care Center

## Portable Calving & Sick Pen

- Provides a portable and self-contained working area to assist with calving and calf acceptance (nursing) problems
- Ideal cattle work area for smaller operations
- One-man operation and complete portability make it an essential part of any cattle operation
- Accepts any Big Valley® Headgate
- The squeeze gate is split, to allow it to swing out of the way to correct nursing problems, graft calves to cows or perform caesareans
- It can be swung completely out of the way to form a 10' x 8' or 10' x 10' pen
- Comes standard with 8' or 10' panels but can be enlarged by using 12', 14' or 16' side panels; the 4' access door provides easy entrance
- The Split Squeeze Gate can be swung out of the way to convert the Portable Care Center into a pen for treating and containing sick animals



AVAILABLE COLORS: ● GREEN

DESCRIPTION	LBS.	ITEM NO.
10' x 8' Care Center w/o Headgate	740	62074492
10' x 8' Care Center w/ CL-5 Headgate	970	62074482
10' x 10' Care Center w/o Headgate	770	62074472
10' x 10' Care Center w/ CL-5 Headgate	1000	62074462

### Components

DESCRIPTION	LBS.	ITEM NO.
Care Center Front Panel	300	62174502
Care Center Hardware	38	62174511
Arch & Gate	240	62174522
2" 16 Gauge Corral Panel (8' x 66" High)	80	44123082
2" 16 Gauge Corral Panel (10' x 66" High)	95	44123102
Latch Assembly	22	62174511

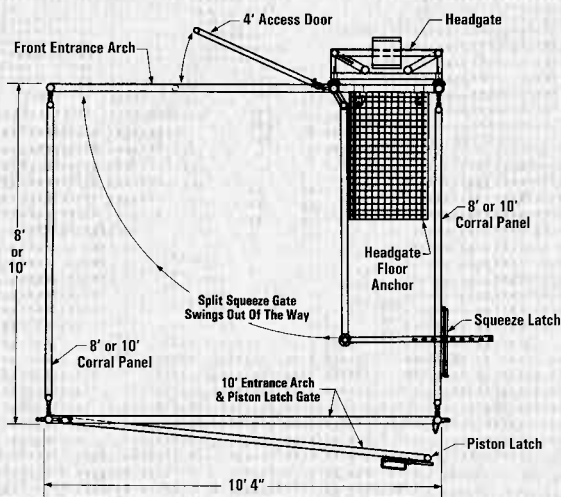

### Latch Kit

DESCRIPTION	LBS.	ITEM NO.
Arm		62403031
Base Arm		62403021
Hardware		62174511

### Recommended Headgate

DESCRIPTION	LBS.	ITEM NO.
CL-5 Headgate	235	60110202



# Unsheeted System Components



## Behlen Country Unsheeted System Components

DESCRIPTION	LBS.	SHIP UPS	ITEM NO.
10' Sweep Pen Gate Only	89	-	46160292
10' Gate Arch Only	113	-	46180222
Latch and Hardware	23	✓	46180272
10' Curved Sweep Pen Panel	120	-	46179572
10' Panel with Alley Arch	104	-	46180232
10' Straight Crowd Alley Panel	100	-	46160282
8' Straight Crowd Alley Panel (also for use w/ platform scales)	82	-	46160272
Non-adjustable Alley Arch	47	-	46112232
Unsheeted Adjustable Alley Arch	62	-	64160612
Sweep Pen Overhead Brace	38	-	46160312
10' Unsheeted Cut Out Panel	114	-	46160352
Rear Adj. Arch w/ Tailgate	170	-	46160512
Unsheeted Alley Arch w/ Fender	75	-	64160622
Unsheeted Adj. Alley Arch	62	-	64160612
Non-adjustable Alley Arch	47	-	46112232
Crowd Alley Reversible Leg & Handle	40	-	64160542
10' Unsheeted Crowd Alley Add-on <i>Includes (2) 46160282 and (1) 64160612</i>	360	-	46179622
Drop Down No Back	55	✓	64160092
20' Adjustable Unsheeted Crowd Alley	616	-	46079592
Roller Gate	284	-	46168892



## Unsheeted System Kit 1

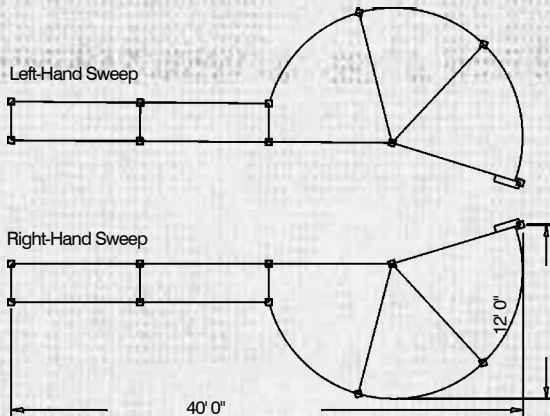

180-degree Sweep with 10' Straight lead-in Panel with 20' of Adjustable Straight Crowd Alley. Includes Drop Down No Back.

- **Item No. 46079642 (Model No. USK1)**  
Will make either of the two systems drawn

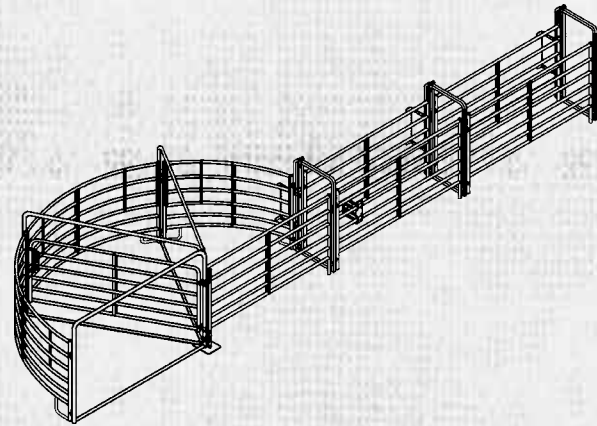

### Components

DESCRIPTION	QTY.	ITEM NO.
10' Gate Arch Only	1	46180222
10' Sweep Pen Gate	1	46160292
Sweep Pen Overhead Brace	1	46160312
10' Curved Sweep Pen Panel	3	46179572
Flat Ground Brace	2	46180212
Latch & Hardware	1	46180272
10' Straight Crowd Alley Panel	5	46160282
Unsheeted Adj. Alley Arch with Fender	1	64160622
Drop Down No Back	1	64160092
Unsheeted Adj. Alley Arch	2	64160612

## Unsheeted System Kit 2

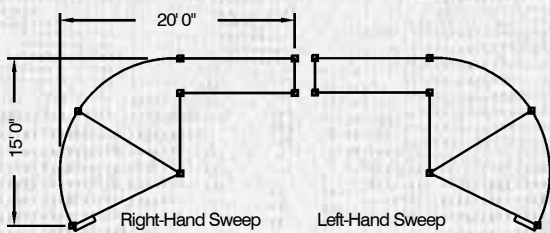

120-degree Sweep with 10' Straight Crowd Alley.

- **Item No. 46080002**  
Will make either of the two systems drawn

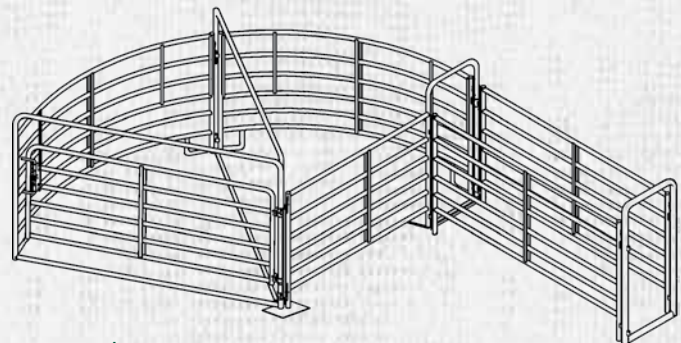

### Components

DESCRIPTION	QTY.	ITEM NO.
10' Gate Arch Only	1	46180222
10' Sweep Pen Gate	1	46160292
Sweep Pen Overhead Brace	1	46160312
10' Curved Sweep Pen Panel	2	46179572
Flat Ground Brace	1	46180212
Latch & Hardware	1	46180272
Drop Down No Back	1	64160092
10' Panel with Alley Arch	1	46180232
10' Straight Crowd Alley Panel	2	46160282
Alley Arch Weld Assembly	1	46112232



## Unsheeted System Kit 3

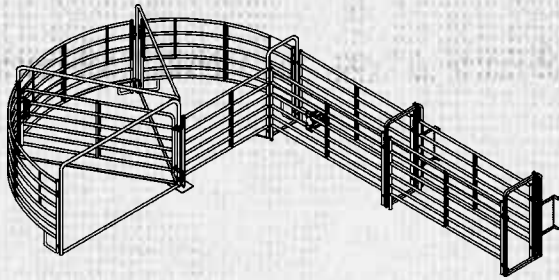

180-degree Sweep with 20' Straight Adjustable Crowd Alley.  
Includes Overhead Sweep Pen Brace and Drop Down No Back.

- **Item No. 46079662 (Model No. USK3)**  
Will make either of the two systems drawn.

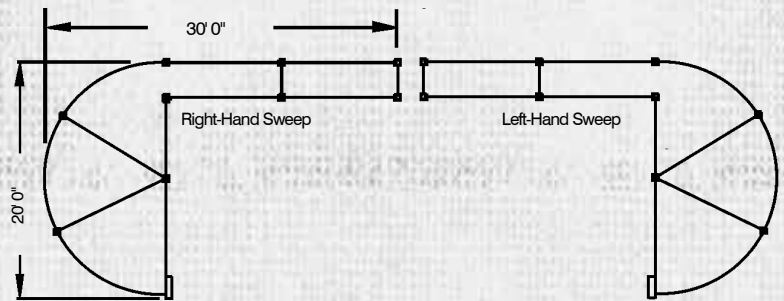

### Components

DESCRIPTION	QTY.	ITEM NO.
10' Gate Arch Only	1	46180222
10' Sweep Pen Gate	1	46160292
Sweep Pen Overhead Brace	2	46160312
10' Curved Sweep Pen Panel	3	46179572
Flat Ground Brace	2	46180212
Latch & Hardware	1	46180272
10' Straight Crowd Alley Panel	4	46160282
Drop Down No Back	1	64160092
10' Panel with Alley Arch	1	46180232
Unsheeted Adj. Alley Arch	2	64160612

## Unsheeted System Kit 4

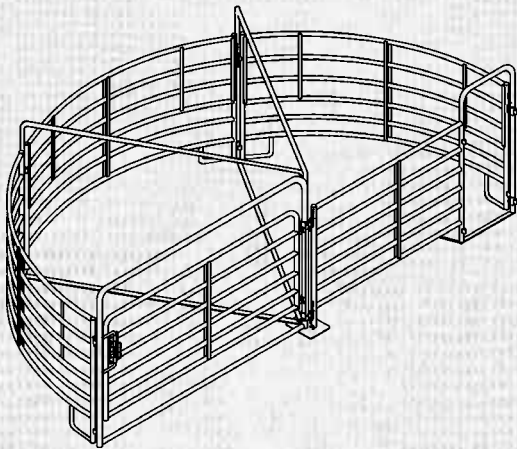

180-degree 3-Panel Sweep Pen.

- **Item No. 46079532 (Model No. USK4)**  
Will make either of the two systems drawn.

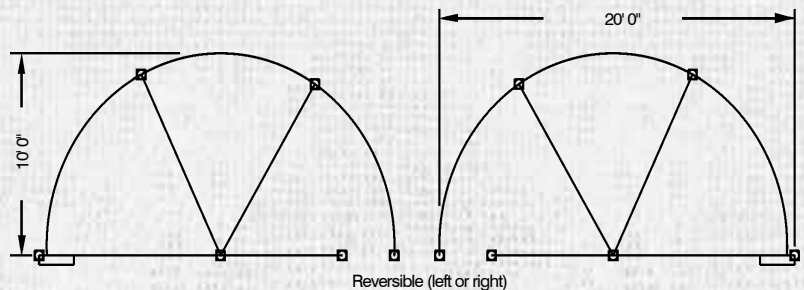

### Components

DESCRIPTION	QTY.	ITEM NO.
10' Gate Arch Only	1	46180222
10' Sweep Pen Gate	1	46160292
Sweep Pen Overhead Brace	2	46160312
10' Curved Sweep Pen Panel	3	46179572
Flat Ground Brace	2	46180212
Latch & Hardware	1	46180272
10' Panel with Alley Arch	1	46180232



## Unsheeted System Kit 5

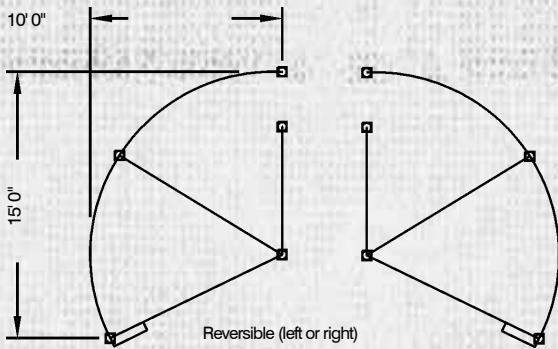

120-degree 2-Panel Sweep Pen.

- **Item No. 46079542 (Model No. USK5)**  
Will make either of the two systems drawn.

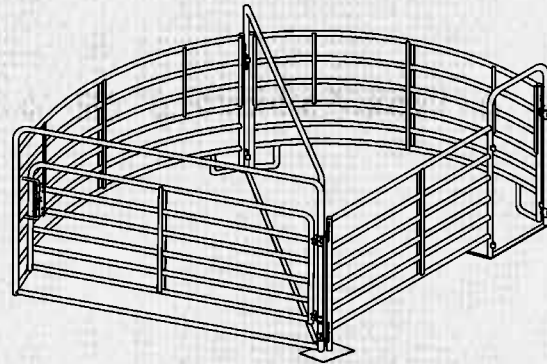

### Components

DESCRIPTION	QTY.	ITEM NO.
10' Gate Arch Only	1	46180222
10' Sweep Pen Gate	1	46160292
Sweep Pen Overhead Brace	1	46160312
10' Curved Sweep Pen Panel	2	46179572
Flat Ground Brace	1	46180212
Latch & Hardware	1	46180272
10' Panel with Alley Arch	1	46180232

## Unsheeted System Kit 6

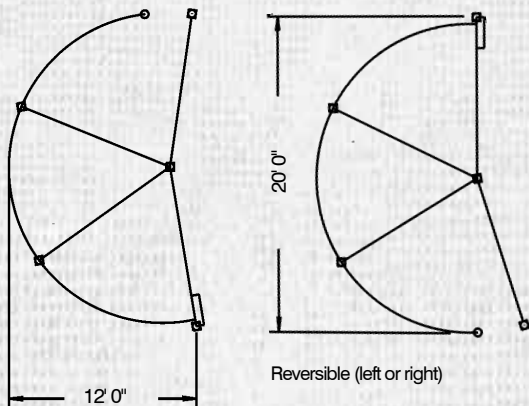

180-degree 3-Panel Sweep Pen with a 10' Straight lead-in Panel.

- **Item No. 46079602 (Model No. USK6)**  
Will make either of the two systems drawn.

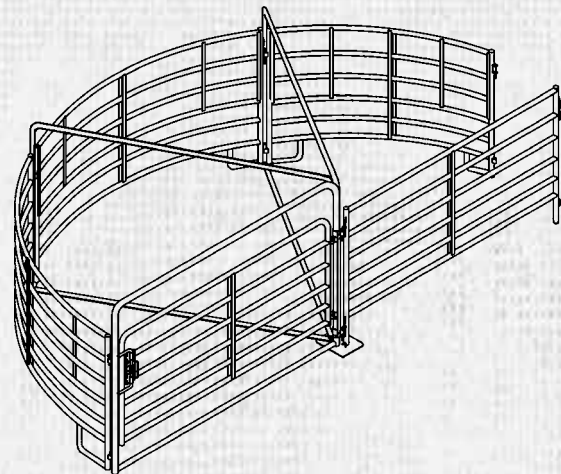

### Components

DESCRIPTION	QTY.	ITEM NO.
10' Gate Arch Only	1	46180222
10' Sweep Pen Gate	1	46160292
Sweep Pen Overhead Brace	2	46160312
10' Curved Sweep Pen Panel	3	46179572
Flat Ground Brace	2	46180212
Latch & Hardware	1	46180272
10' Straight Crowd Alley Panel	1	46160282



# 3-Point Point

## Rotary Cutters

Behlen Country Rotary Cutters are solid performers built for rugged abuse.

### Heavy Duty Cutter



#### Features

- Get out and get mowing with quick assembly
- Long-lasting, UV resistant powder coat finish
- 80 HP Series
  - 6' is Category 1 and 2
  - 7' is Category 1 and 2
- One of the heaviest decks in the industry takes on the abuse
- Cut in confidence with 6½" deep sides to hold in debris
- Premium 3½" wide heat treated, U.S. made forged blades for longer life
- Ideal for frequent stops and starts, each rotary cutter comes complete with a heavy duty cast iron 540 RPM shear bolt gear box
- Heavy Duty Cutters are built with heavy duty flywheels.

***Behlen Country Rotary Cutters are ready to handle the challenges of cutting brush up to 2.25" in diameter, pasture maintenance, grass, and shredding crop residue as well as road right-of-way maintenance.***

DESCRIPTION	LBS	ITEM NO.
6' Heavy Duty Taper Back Cutter (Fits Category 1 & 2) 80 HP Slip Clutch	993	80110080YEL
7' Heavy Duty Taper Back Cutter (Fits Category 1 & 2) 80 HP Slip Clutch	1189	80110090YEL



# Medium Duty Cutter

## Features

- Get out and get mowing with quick assembly
- Long-lasting, UV resistant powder coat finish
- 40 HP Series are Category 1 hitch capable
- Adjustable, laminate puncture resistant rear wheel
- One of the heaviest decks in the industry takes on the abuse
- Cut in confidence with 6½" deep sides to hold in debris
- Premium 3½" wide heat treated, U.S. made forged blades for longer life
- Category 1 pins included with purchase
- Ideal for frequent stops and starts, each rotary cutter comes complete with a heavy duty cast iron 540 RPM shear bolt gear box
- Added insurance for years of use, a balanced stump jumper protects the gear box.



DESCRIPTION	LBS	ITEM NO.
4' Medium Duty Taper Back Cutter (Fits Category 1) 40 HP Shear Bolt	527	80110040YEL
5' Medium Duty Taper Back Cutter (Fits Category 1) 40 HP Shear Bolt	677	80110050YEL
6' Medium Duty Taper Back Cutter (Fits Category 1) 40 HP Shear Bolt	746	80110060YEL
Chain Guard for 4' Cutter	71	80110465
Chain Guard for 5' Cutter	79	80110475
Chain Guard for 6' Cutter	89	80110485



Chain Guards



# 3-Point

## Grader Blades

### Grader Blades

#### Heavy Duty Adjustable

Behlen Country Heavy Duty Adjustable Grader Blades offer the most freedom to tackle big or small jobs. Tilt, angle and offset capabilities offer extra versatility for exceptional grading, scraping, digging and getting at hard to reach jobs.

#### Medium Duty

Behlen Country Medium Duty Grader Blades are ideal for many applications including: driveway maintenance, snow removal, dirt and gravel spreading, and more!



### FEATURES

	Heavy Duty Adjustable	Medium Duty
16" mold board with 6" heat-treated cutting edge	●	●
Forward and reverse blade angle adjustment	●	●
26" offset capabilities either direction	●	
Blade is able to tilt 15° either direction	●	
360° blade rotation with 5 settings - index plate adjustment	●	●
Category 1 quick hitch compatible	●	●
Long-lasting, UV resistant powder coat finish	●	●





Heavy Duty Adjustable pictured above.

## Hitch `N Plow

Behlen Country Hitch `N Plow allows you to turn your truck, SUV or UTV into a compact tractor.

With Hitch `N Plow you can attach many standard Category 1 non-PTO driven 3-point implements such as grader blades, landscape rakes and box blades using a standard 2" receiver hitch. 30" x 2" x 28" inches



DESCRIPTION	LBS	ITEM NO.
6' Heavy Duty Adjustable Grader Blade	358	80110910YEL
7' Heavy Duty Adjustable Grader Blade	375	80110920YEL
5' Medium Duty Grader Blade	212	80110800YEL
6' Medium Duty Grader Blade	228	80110810YEL
7' Medium Duty Grader Blade	277	80110820YEL
Hitch `N Plow	32	80119995



# 3-Point Point

## Box Blades

### Box Blades

Behlen Country Box Blades are designed for a multitude of applications including: landscaping, gravel work, driveways, light construction, and leveling. Boxed ends keep the material being worked where you want it.

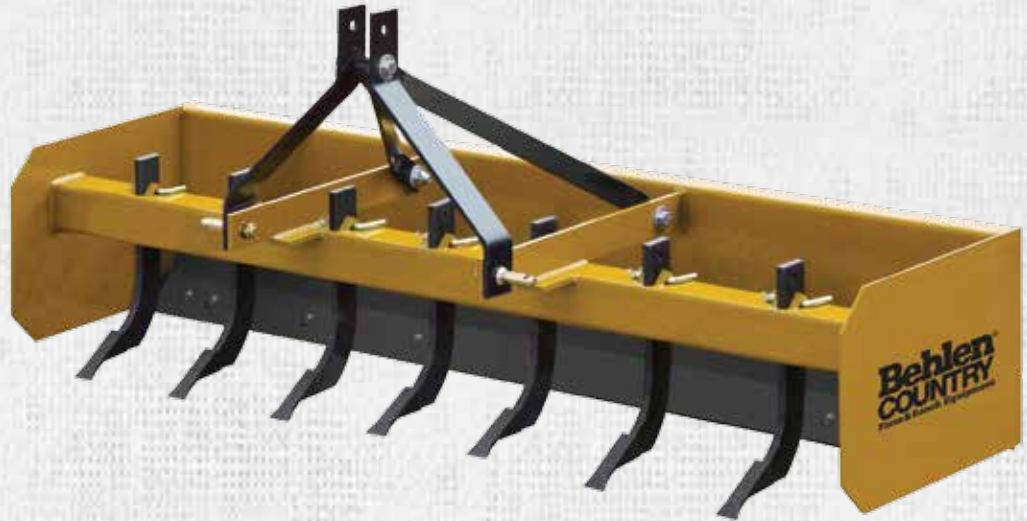

### FEATURES

- Cut as deep as you need with 3 depth adjustments on ripping shanks
- Long-life shanks with heat-treated cutting edges
- Front and rear reversible cutting edges
- Long-lasting UV resistant powder coat finish
- Category 1 quick hitch compatible
- Heavy Duty 7' & 8' models fit Category 1
- Heavy 4" tool bar holds up during deepest penetration



DESCRIPTION	LBS	ITEM NO.
5' Heavy Duty Box Blade, 5 Shank (heat treated cutting edge)	415	80111100YEL
6' Heavy Duty Box Blade, 6 Shank (heat treated cutting edge)	500	80111110YEL
7' Heavy Duty Box Blade, 6 Shank (heat treated cutting edge)	530	80111120YEL



# Landscape Rakes

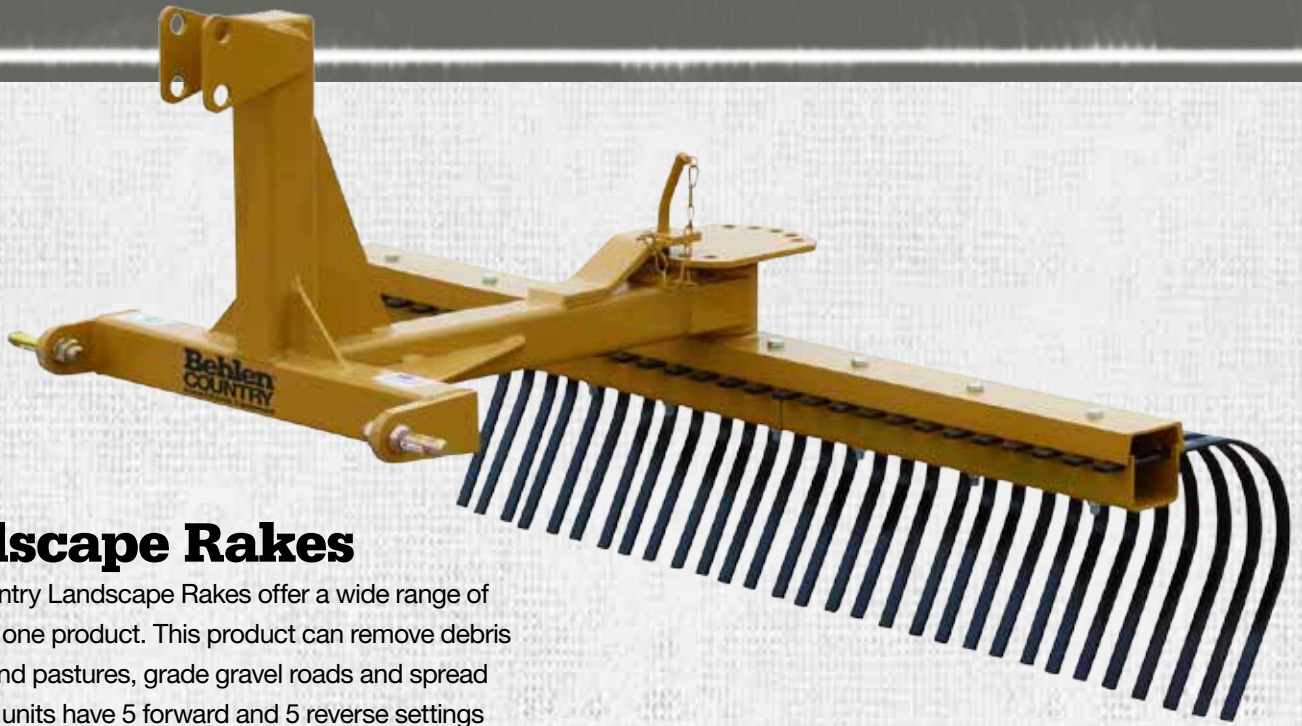

## Landscape Rakes

Behlen Country Landscape Rakes offer a wide range of versatility in one product. This product can remove debris from trails and pastures, grade gravel roads and spread topsoil. The units have 5 forward and 5 reverse settings and can be quickly changed to pull or push depending on the chore being done. Add the optional wheel kit for height adjustment above grade.

### FEATURES

- 360° rotation with 5 settings - index plate adjustment
- Suggested for 20-50 HP tractors
- Quick hitch compatible
- Category 1 hitch compatible
- Long-lasting, UV resistant powder coat paint
- Optional Wheel Kit available for all models



DESCRIPTION	LBS	ITEM NO.
5' Medium Duty Landscape Rake	225	80110600YEL
6' Medium Duty Landscape Rake	240	80110630YEL
7' Medium Duty Landscape Rake	280	80110640YEL
Wheel Kit to fit Medium & Heavy Duty Landscape Rakes	40	80110665



# Rotary Tiller

## Rotary Tiller

Behlen Country Rotary Tiller is the answer to your large area tilling needs. The heavy duty cast iron gearboxes feature 100% gear driven reliability with the protection of oil lubrication and a slip clutch PTO drive shaft. Self-sharpening heat treated tines will cut through the toughest soils behind your 25-60 HP tractor. Includes adjustable feet to control your tilling depth, and is finished with long-lasting UV resistant powder coat finish.

### FEATURES

- Heavy-Duty Cast Iron 25-60 H.P. Gear Box
- All Gear Driven Side Gear Box
- Self-Sharpener Heat Treated Tines
- Long-lasting UV resistant powder coat finish
- Category 1 Hookups
- Quick Hitch Compatible



DESCRIPTION	LBS	ITEM NO.
4' Rotary Tiller	595	80118040YEL
5' Rotary Tiller	642	80118050YEL
6' Rotary Tiller	710	80118060YEL



# Tillage Discs

## Tillage Disc

### Heavy Duty

Behlen Country Heavy Duty Tillage Disc is the heaviest in its class. This tillage disc can be used for general purpose tillage to plowing through even the toughest of soils.



### Medium Duty

Behlen Country Medium Duty Tillage Disc is built for working small plots of land, such as gardens and wildlife food plots. The combination of notched and smooth discs easily break up hard ground and prepare it for planting.



## FEATURES

	Heavy Duty	Medium Duty
Heavy duty square steel tube box frame design	●	
Heavy duty welded angle frame		●
Adjustable disc gangs (adjust depth and angle)	●	●
Long-lasting sealed bearings	●	
Cast iron bearings		●
Long-lasting, UV resistant powder coat finish	●	●
Category 1 quick hitch compatible	●	●

DESCRIPTION	LBS	ITEM NO.
6½' Heavy Duty Tillage Disc 20/18	786	80111320YEL
7½' Heavy Duty Tillage Disc 24/18	851	80111330YEL
6½' Medium Duty Tillage Disc 20/18	530	80111210YEL
7½' Medium Duty Tillage Disc 24/18	602	80111220YEL



# 3-Point

## Middle Buster & Sub Soiler

### Middle Buster (Potato Plow)

The Behlen Country Middle Buster has a sturdy shank and added angle bracing support for the 15" double wing cutting blade. This single row cutting can dig through the toughest of soils.

#### FEATURES

- Rated for tractors under 50 HP
- Category 1 hitch compatible
- Long-lasting, UV resistant powder coat finish

### Sub Soiler

The Behlen Country Sub Soiler is a great way to drain areas where water accumulates and break up compacted soil to improve plant growth. The one piece welded frame ensures years of life, and the replaceable point allows for easy maintenance.

#### FEATURES

- Rated for tractors under 50 HP
- Category 1 hitch compatible
- Long-lasting, UV resistant powder coat finish



DESCRIPTION	LBS	ITEM NO.
Middle Buster (Fits Category 1 Hitch Tractors)	82	80111710YEL
Sub Soiler (Fits Category 1 Hitch Tractors)	96	80111720YEL





# Dirt Scoop & Cultivator

## Dirt Scoop

Forget the shovel and wheel barrow! The Behlen Country Dirt Scoop digs, carries, dumps and spreads in forward or reverse. This is an excellent tool around a homestead or for small grounds maintenance.

### FEATURES

- Rope attachment option for easy dumping without getting off your tractor (rope not included)
- Beveled cutting edge makes digging easier
- Dig in forward or reverse
- Category 1 hitch compatible
- Long-lasting, UV resistant powder coat paint



## Cultivator

### One Row

Behlen Country One Row Cultivators are designed for the small farm or acreage owner who wants to maintain a small garden and food plots. The cultivator works well for preparing soils for planting, weed control, and incorporating organics into the soil.

### FEATURES

- Heavy angle iron frame
- Six heat-treated replaceable cultivator tines
- Category 1 hitch pins
- Long-lasting, UV resistant powder coat finish



DESCRIPTION	LBS	ITEM NO.
30" Dirt Scoop	272	80112110YEL
One Row Cultivator	118	80111500YEL



# 3-Point

## Hay Moving Implements

### Bale Spears

Behlen Country Bale Spears can serve all your bale moving needs from the heaviest to lightest.

#### HEAVY DUTY BALE SPEAR

- Long-lasting, constructed of heavy duty steel
- Heat-treated welded spear makes moving heavy bales easy
- Category 1 and Category 2 hitch compatible
- Long-lasting, UV resistant powder coat paint
- Recommended for lifting bales up to 2,000 lbs.



#### BUCKET BALE SPEAR

- Mounts to most bucket loaders with a single bolt
- Heat-treated welded spear makes moving bales easy
- Long-lasting, UV resistant powder coat paint
- Capable of lifting bales up to 2,000 lbs.



DESCRIPTION	LBS	ITEM NO.
Heavy Duty Bale Spear	105	80112660YEL
Bucket Bale Spear	71	80112620YEL



## FRONT LOADER BALE SPEAR

- Recommended for lifting bales up to 2,000 lbs.
- Will fit most tractors



## SKID STEER BALE MOVER

- Universal Attachment
- Angled Spear point to assist in bale tip back at lower lift
- Replaceable Spear and Stabilizer Points



## HEAVY DUTY BALE MOVER

- Lift bales with confidence using this heavy duty bale mover.
- The heavy duty pipe along with the stabilizer point can easily lift bales up to 3,000 lbs.
- Complete with Category 2 pins and includes Category 3 sleeves
- Reduces the damage to bales with smooth edge construction
- Long-lasting, UV resistant powder coat paint



DESCRIPTION	LBS	ITEM NO.
Front Loader Bale Spear	101	80112670YEL
Skid Steer Bale Mover	190	80112635
Heavy Duty Bale Mover	250	80160500YEL



# 3-Point Lifting Implements

## Carry Alls

Behlen Country Carry Alls are a great companion for your moving needs. A variety of platforms can be constructed for your moving needs.

### FEATURES

- 1,000 lbs. capacity
- Pre-punched legs for easy platform attachment
- Category 1 hitch compatible
- Long-lasting, UV resistant powder coat paint



## Boom Poles

Behlen Country Boom Poles are a great tool for farmers and ranchers. They can assist with loading, lifting and pulling.

### FEATURES

- Heavy Duty is built with strong square tubing
- Medium Duty is built to last with schedule 40 tubing construction
- Category 1 hitch compatible
- Long-lasting, UV resistant powder coat paint
- Heavy Duty weight capacity 1,000 lbs.
- Medium Duty weight capacity 500 lbs.



Heavy Duty



Medium Duty

DESCRIPTION	LBS	ITEM NO.
Heavy Duty Carry All	95	80112410YEL
Heavy Duty Square Boom Pole - Category 1 & 2	64	80112510YEL
Medium Duty Round Boom Pole	62	80112500YEL



# Drag Harrow & Land Plane

## Drag Harrow

Behlen Country Drag Harrows have so many uses that we can't list them all. Built with heavy 1/2" x 4" tines and 2" heavy seamless draw bar, these are work horses. They can be easily reversed to allow for less aggressive penetration. Some of the more common uses are: leveling riding arenas, preparing seed beds, reconditioning driveways, incorporating broadcast seeds, spreading manure in pastures, and beach conditioning. Coated with premium powder coat paint. Imported.



## Land Plane

Our new Behlen Country Land Plane is perfect for maintaining driveways, gravel roads and for final leveling work. With two cutting edges and a 7' width, you will make short work of big grading jobs.

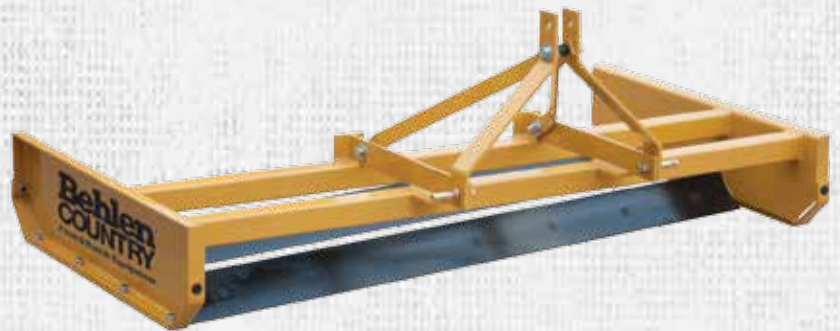

- Great for grading driveways, leveling land, or reconditioning gravel roads
- Wide enough to cover your tractor tracks and maintain most drives in two passes
- 84" grading width
- Two replaceable cutting edges for maximum grading
- Rear 3-point hookup quick-hitch compatible
- Recommended for tractors up to 40HP
- Category 1 quick hitch compatible
- Replaceable bottom wear strips on sidewalls



## Arena Ace

Create excellent footing for your equestrian needs with this arena groomer offered by Behlen Country. Whether you have a commercial facility or small training barn, this groomer adjusts to be suitable for a variety of needs and conditions. With ease it creates a good base and finished top surface. This groomer's s-tines can be adjusted to your desired depth, ensuring penetration of the surface and break down of dirt clumps. The leveling bar behind the s-tines levels any hills or valleys. Behind the leveling bar is a set of roller bars that leave a nice, finished surface. This groomer is ideal to be used with category 1 or 2 tractor and works great in dirt or sand arenas.

DESCRIPTION	LBS	ITEM NO.
48" x 48" Drag Harrow	116	3018371
72" x 60" Drag Harrow	153	3018264
96" x 60" Drag Harrow	191	3018263
84" Land Plane	497	80119070YEL
96" Arena Ace	550	80117385



# Miscellaneous Equipment

## Universal Skid Steer Mount

Behlen Country's Universal Skid Steer Mount allows you to easily hook any attachment to your skid steer loader. Simply weld this mount to your loader bucket, bale mover, forklift, or an endless variety of other custom attachments. Made to SAE-J2513 standards; this will fit most skid steer major brands.



## 3-Point Hitch Mover

### Heavy Duty

The Behlen Country Heavy Duty 3-Point Hitch Mover has a multitude of uses, from moving gooseneck trailers, ball hitch wagons on the farm to moving boats at the lake. These Hitch Movers cover it all. Comes with a 2- 5/16" welded top ball, slide in section for any 2" receiver, and Category 1 and 2 lift pins. Rated for over 10,000 lbs.



## 3-Point Spreaders

Behlen Country's 3 Point Spreaders feature a seamless one piece hopper with a 850# capacity (dependent on product), available in both steel and corrosion resistant Poly. This PTO driven spreader includes an in-hopper agitator and spreads up to 46', with directional spreading available. The Pull behind spreader features a 650# capacity steel hopper and can be used with an ATV or Lawn Tractor for a variety of spreading uses.



DESCRIPTION	LBS	ITEM NO.
Universal Skid Steer Mount	96	80112725
Heavy Duty 3-Point Hitch Mover	77	80160600YEL
3-Point Spreader (Red) 850# Capacity	135	80112701
Poly 3-Point Spreader (Yellow & Red) 500# Capacity	125	80112751
Pull Type Spreader (Red) 650# Capacity	179	80112741



# 3-Point Replacement Parts

## Replacement Parts

ITEM NO.	ROTARY CUTTERS	LIFT PIN	PTO SHAFT	GEAR BOX	STUMP JUMPER	CUTTER BLADE	BLADE BOLT	BLADE NUT	BLADE WASHER	DECAL ROTARY SAFETY SHEET
80110040YEL	4' Medium Duty	3018352	1728011	2088052	2088026	3018433	1308012	1308015	1308016	16881000
80110050YEL	5' Medium Duty	3018352	1728012	2088028	2088026	3018434	1308012	1308015	1308016	16881000
80110060YEL	6' Medium Duty	3018352	1728012	2088028	2088026	3018435	1308012	1308015	1308016	16881000
80110080YEL	6' Heavy Duty	3018393	Call	Call	80412755	3018435	1308027	1308015	1308016	16881000
80110090YEL	7' Heavy Duty	3018393	Call	Call	80412835	3018435	1308027	1308015	1308016	16881000

ITEM NO.	BOX BLADES	CATEGORY 1 LIFT PIN	3" BENT HITCH PIN	SHANKS	CUTTING EDGE
80111100YEL	5' Heavy Duty	3018352	3018382	3018351	3018378
80111110YEL	6' Heavy Duty	3018352	3018382	3018351	3018379
80111120YEL	7' Heavy Duty	3018352	3018382	3018351	3018380

ITEM NO.	GRADER BLADES	CATEGORY 1 LIFT PIN	CUTTING EDGE
80110800YEL	5' Medium Duty	3018352	3018378
80110810YEL	6' Medium Duty	3018352	3018379
80110820YEL	7' Heavy Duty	3018352	3018380
80110900YEL	5' Heavy Duty Adjustable	3018352	3018378
80110910YEL	6' Heavy Duty Adjustable	3018352	3018379
80110920YEL	7' Heavy Duty Adjustable	3018352	3018380

ITEM NO.	LANDSCAPE RAKE	CATEGORY 1 LIFT PIN	RAKE TINES
80110600YEL	5' Medium Duty	3018352	3018367
80110630YEL	6' Medium Duty	3018352	3018367
80110640YEL	7' Medium Duty	3018352	3018367



# 3-Point

## Sub-Compact Implements

### Rotary Cutter

Behlen Country's Sub-Compact Rotary Cutter is built to last. Supplied with Category 1 pins on Category 0 spacing, this is the perfect unit for your sub-compact tractor. Gear box with shear bolt is rated up to 40 HP. American made blades and a steel stump jumper are just a few of the features of this cutter.



### Tillage Disc

The Behlen Country Sub-Compact Disc is ideal for small gardens and food plots. All notched blades offer better penetration. Category 1 pins on Category 0 spacing.



### Middle Buster/ Sub Soiler Combo

Behlen Country's Middle Buster/Sub Soiler Combo can be used for a multitude of chores. Planting, cultivating and ditching are just a few of these. Category 1 pins on Category 0 spacing.



DESCRIPTION	LBS	ITEM NO.
4' Rotary Cutter 40 HP Gear Box Shear Bolt	400	80110030ORG
5½' Tillage Disc	425	80111340ORG
Middle Buster/Sub Soiler Combo	80	80111700ORG



Behlen Country's Sub-Compact (SC) lines start with the strength and versatility of the big boys blended with the agile handling and size you expect from your Sub-Compact (15-30 HP) tractor. All of our SC line implements are fully featured and have the same warranty and quality standards you expect from the rest of our 3-Point lineup.

Don't let the size fool you, these implements are designed for years of safe, reliable use. The premium powder coat finish will provide fade resistant, long lasting pride of ownership. Don't get fooled by low quality, liquid paint found in other lines. Identified by their orange color, the Behlen Country SC implements provide endless possibilities for use of your small tractor.

## Grader Blades

Behlen Country Sub-Compact Blades are ideal for applications such as driveway maintenance and snow removal. Reversible, heat-treated blades allow for long lasting durability. Behlen Country Grader Blades can be adjusted to five settings forward and reverse. Category 1 pins on Category 0 spacing.



## Box Blade

Behlen Country's Sub-Compact Box Blade is ideal for driveway maintenance, snow removal, dirt, gravel spreading and more. Heat-treated blades allow for long lasting durability. Adjustable shanks allow for deep ripping. Category 1 pins on Category 0 spacing.



## Landscape Rake

Behlen Country's Sub-Compact Landscape Rake is great for clearing a trail, driveway maintenance and numerous other chores. Five forward and five reverse settings. Category 1 pins on Category 0 spacing.



DESCRIPTION	LBS	ITEM NO.
5' Grader Blade	191	80110710ORG
4' Box Blade	292	80111000ORG
5' Landscape Rake	186	80110610ORG



# Dog Kennels

More than just a kennel to your dog, this is home.

## Magnum Kennels™

Strongest and most durable kennel available. No other kennel features 6 gauge wire mesh. Twenty-five percent thicker than others to contain the most active dogs.

### Hot-Dipped Galvanized

- Rust inhibiting hot-dipped galvanized coating for years of rust free performance
- Stronger than other welded wire kennels due to the center vertical support and heavy gauge mesh
- Long lasting 2" x 4" 6 gauge hot-dipped mesh – the heaviest in the industry
- Heavy 1-5/8" hot-dipped galvanized tubular frame
- Plated, lockable, slam latch
- Modular and portable
- Recommended for residential and commercial operations
- Easy assembly, no tools required
- Steel mesh and sun shade tops available
- Made in the U.S.A.



MAGNUM KENNEL™	L/ W/ H	DOORS	LBS.	ITEM NO.
Complete Kennel	10' x 10' x 6'	1	382	38100229
Complete Kennel	5' x 10' x 6'	1	302	38100339
Single Door Panel	10' x 6'	1	103	38100019
Double Door Panel	10 x 6'	2	121	38100099
Single Door Panel	5' x 6'	1	64	38100079
Expansion Panel	10' x 6'	0	88	38140069
Expansion Panel	5' x 6'	0	51	38100089

## Magnum Kennel™ Configurations

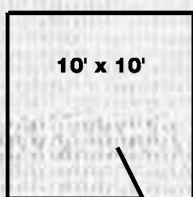

**10' x 10'**

10' x 10' x 6' High  
(3) 10' Side Panels  
(1) 10' Door Panel  
-Each Panel  
includes connectors

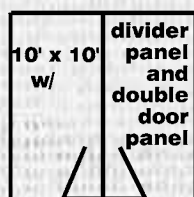

**10' x 10'**

10' x 10' x 6' High  
w/Divider Panel & Double  
Door Panel  
(4) 10' Side Panels  
(1) 10' Double Door Panel  
-Each Panel  
includes connectors

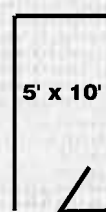

**5' x 10'**

5' x 10' x 6' High  
(2) 10' Side Panels  
(1) 5' Side Panel  
(1) 5' Door Panel  
-Each Panel  
includes connectors

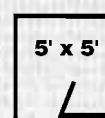

**5' x 5'**

5' x 5' x 6' High  
(3) 5' Side Panels  
(1) 5' Door Panel  
-Each Panel  
includes connectors



## Powder Coated

- Rust inhibiting zinc rich primer, top coated with our premium gray powder coat paint provides an attractive appearance and longer life
- Robust 1-5/8" tubing and heavy 6 gauge 2" x 4" mesh
- Configurable to fit any size yard or dog
- Stronger more secure and attractive alternative to chain link kennels
- Easy to assemble, no tools required
- Wire mesh and sun shade tops available
- Residential use only
- Made in the U.S.A.

MAGNUM KENNEL™	L / W / H	LBS.	ITEM NO.
Complete Kennel	10' x 10' x 6'	385	38100227
Complete Kennel	5' x 10' x 6'	283	38100337
Single Door Panel	10' x 6'	108	38100017
Single Door Panel	5' x 6'	69	38100077
Double Door Panel	10' x 6'	125	38100097
Expansion Panel	10' x 6'	88	38140067
Expansion Panel	5' x 6'	49	38100087





# Chain Link Kennels

More than just a kennel to your dog, this is home.

## Value Chain Link Kennels

### Galvanized

- Cast aluminum square corner fittings for ultimate strength and animal safety
- Center vertical support for added strength
- Pre-assembled panels
- 1" Clearance under panels
- Open bottom vertical tubes for drainage
- Made in the U.S.A.

VALUE CHAIN LINK	L / W / H	LBS	ITEM NO.	PALLET QTY.
Complete Kennel	10' x 10' x 6'	181	441006	4
Complete Kennel	6' x 8' x 4'	117	440684	4
Single Door Panel	10' x 6'	59	401106	16
Single Door Panel	6' x 4'	37	401604	16
Expansion Panel	10' x 6'	41	400106	16
Expansion Panel	6' x 4'	23	400604	16
Expansion Panel	8' x 4'	27	400804	16





# Dog Kennel Accessories

## Kennel Accessories

### A. Steel Mesh Top

- Turns kennel into a secure cage
- Constructed of heavy duty welded wire
- Hot-dipped galvanized
- Fastened with strong, easy-to-use butterfly connectors
- Powder Coated - Club Kennel

### B. Sunblock Top™

- Made of woven 100% UV-treated polypropylene with reinforced brass grommets
- Reduces the temperature inside the kennel by up to 15°F
- Not for use with ice or snow loads, not waterproof

### C. Slam Latch Kit

- This latch is used to work with the Magnum Kennel™
- Latch can be shut from the inside or outside of kennel and will automatically latch

### D. Club Kennel Latch Kit

- Drop down latch

DESCRIPTION	L / W	LBS	ITEM NO.
A. Steel Mesh Top - Galvanized	5' x 10'	68	38140019
A. Steel Mesh Top - Powder Coated	10' x 10'	155	38140027
A. Steel Mesh Top - Powder Coated	5' x 10'	70	38140017
B. Sunblock Top™	10' x 10'	20	900901
C. Slam Latch Kit	-	1	38900128
D. Club Kennel Latch Kit	-	1	38900079
Chain Link Kennel Latch	-	1	900975A
Butterfly Clamps Magnum (2 pair per Pkg.)	-	2	38900069
Butterfly Clamps Club (2 pair per Pkg.)	-	2	38900067
Butterfly Clamps Chain Link (4 pair per Pkg.)	-	2	900319AM
Butterfly Clamps Chain Link (8 pair per Pkg.)	-	2	900319BM
Plastic Cap	-	-	1448107



Steel Mesh Top



Sunblock Top™



Slam Latch Kit



Club Kennel Latch Kit



Butterfly Clamps Magnum



Butterfly Clamps Club



Butterfly Clamps Chain Link



Plastic Cap



## *Delivering the Best Value to our Customers*

### **Direct Ship to retail stores**

Thanks to three convenient plant locations and an in-house trucking company, we can rapidly supply your retail stores, saving you costly handling and inventory carrying charges.

### **Truckload pricing**

Behlen Country offers the broadest collection of farm and ranch products available from a single source, allowing you to combine orders for diverse lines on the same truck. With Behlen Country, you can achieve truckload pricing on the entire order.

### **Web listing**

Our attractive new web site showcases the most complete line of products on the market. It also features an updated dealer locator designed to refer all our visitors to the retailer that can supply their favorite Behlen Country products.

[www.behlencountry.com](http://www.behlencountry.com)



## **A Complete Line of Products for Your Country Lifestyle:**



Gates & Corrals



Equine Equipment



Feeders



Tanks & Waterers



Cattle Equipment



3-Point Equipment



Dog Kennels

**Behlen<sup>®</sup>**  
**COUNTRY**  
**Farm & Ranch Equipment**



#### **WORLD HEADQUARTERS:**

Behlen Mfg. Co.  
P.O. Box 569  
Columbus, NE 68602-0569  
Phone: 800-447-2751  
Fax: (402) 563-7447

#### **TEXAS PLANT:**

Behlen Mfg. Co.  
1221 McGregor Drive  
McGregor, TX 76657  
Phone: 800-447-2751  
Fax: (402) 563-7447

#### **WEST COAST PLANT:**

Behlen Mfg. Co.  
4000 23rd St.  
Baker City, OR 97814  
Phone: 800-447-2751  
Fax: (402) 563-7447