



2023
Product Catalog

Behlen[®]
COUNTRY
Farm & Ranch Equipment

Behlen[®] COUNTRY

Behlen Country is the largest division of Behlen Mfg. Co., headquartered in Columbus, NE. Behlen Mfg. Co. is a locally owned company providing quality steel products worldwide. Behlen Country manufactures a complete line of products for farm and ranch, including Gates, Corral Panels, Fence, Tanks/Waterers, Feeders, Cattle Handling, Equine, Small Animal/Pet, and 3-Point Equipment. Many of these items have even been used in the lawn and garden category.

At Behlen Country, we pride ourselves on continuous improvement and customer satisfaction. Our products are designed and tested for “real world” use, whether you are a weekend enthusiast or a professional rancher. If your customers are backyard gardeners or large cattle operations, the Behlen Country brand stands for proven performance and has what they need to succeed.

With three convenient manufacturing locations and an in-house trucking company, BMC Transportation, we can quickly supply your retail stores, saving you handling and inventory costs. Behlen Country offers a diversified product offering of farm and ranch products from a single source, allowing you to combine orders for different products on the same truck and get them when you need them.

We strive for excellence through teamwork and change to make our customers and employees better off. Through our innovative and functional products, being on-time and complete, Behlen Country is proud to earn your business!



Products with this American flag symbol beside them are proudly manufactured in the United States.

Look for these exciting new products!

NEW PRODUCTS

▶ **All Metal Small Animal Feeder -Page 36**



▶ **Poly Creep Feeders -Page 37**



▶ **Square, Triangle, & Utility Galvanized Tanks -Page 40**



▶ **Rigid Poly Tanks & Hog Waterer -Page 41**



▶ **1 Row Hiller -Page 65**



Table of Contents

| | |
|---|---|
| Gate & Corral Panel Performance | 4 |
| Gate & Corral Panel Finish Options..... | 5 |

GATES

| | |
|------------------------|----|
| Heavy-Duty..... | 6 |
| Medium-Duty..... | 8 |
| Utility | 10 |
| Gate Accessories | 12 |

CORRAL PANELS

| | |
|------------------------------------|----|
| How to Calculate a Round Pen | 14 |
| Heavy-Duty..... | 15 |
| Medium-Duty..... | 17 |
| Utility | 18 |
| Kidding Pens | 19 |
| Corral Panel Accessories | 20 |
| Fence Panels..... | 21 |

EQUINE EQUIPMENT

| | |
|----------------------------------|----|
| Modular Horse Stalls..... | 22 |
| Stall Connectors..... | 23 |
| Modular Shelter Kits..... | 24 |
| Modular Shelter Components | 27 |
| Stall Feeders..... | 28 |
| Stable Accessories..... | 29 |

FEEDING EQUIPMENT

| | |
|-----------------------------|----|
| HaySmart™ Feeders | 30 |
| V Bar Hay Feeders | 30 |
| Calf Creep Feeders | 32 |
| Mineral Feeders..... | 33 |
| Feed Bunks & Troughs | 34 |
| Feed Bunks & Hay Racks..... | 35 |
| Small Animal Feeders..... | 36 |

TANKS/WATERERS

| | |
|---------------------------------|----|
| Galvanized Stock Tanks | 38 |
| New Galvanized Tanks | 40 |
| New Rigid Poly Tanks..... | 41 |
| Flex Poly Stock Tanks | 42 |
| Energy-Free Waterers..... | 44 |
| Electric Waterers | 45 |
| Tank & Waterer Accessories..... | 46 |

CATTLE EQUIPMENT

| | |
|-----------------------------------|----|
| Chutes | 48 |
| Headgates | 52 |
| Calf Table & A.I. Cage | 52 |
| Unsheeted System Kits..... | 53 |
| Unsheeted System Components | 56 |
| Portable Care Center..... | 57 |
| Calf Hutch | 58 |
| Anchor Stakes, Post Driver | 58 |

3-POINT EQUIPMENT

| | |
|--------------------------------|----|
| Rotary Cutters | 59 |
| Rotary Tillers..... | 60 |
| Tillage Discs | 60 |
| Grader Blades | 61 |
| Box Blades | 61 |
| Arena Ace™ | 62 |
| Drag Harrows | 62 |
| Land Plane | 63 |
| Landscape Rakes..... | 63 |
| Middle Buster | 64 |
| Cultivator | 64 |
| Sub Soiler | 64 |
| 1 Row Hiller | 65 |
| Heavy-Duty Bale Spear..... | 65 |
| Bucket Bale Spear..... | 65 |
| Carry All..... | 65 |
| Boom Poles..... | 66 |
| 3-Point Hitch Movers | 66 |
| Receiver Wire Un-roller | 66 |
| Spreaders | 67 |
| Post Hole Digger & Augers..... | 67 |
| Hitch'N Plow® | 67 |
| Sub-Compact Implements..... | 68 |

DOG KENNELS

| | |
|-------------------------------|----|
| Value Chain Link Kennels..... | 69 |
| Magnum Kennels™ | 70 |



Gate & Corral Panel Performance

With our good, better, best approach, every Behlen Country gate and corral panel is designed to perform. Rugged, resilient and field proven, simply pick the level of performance you need for your site.

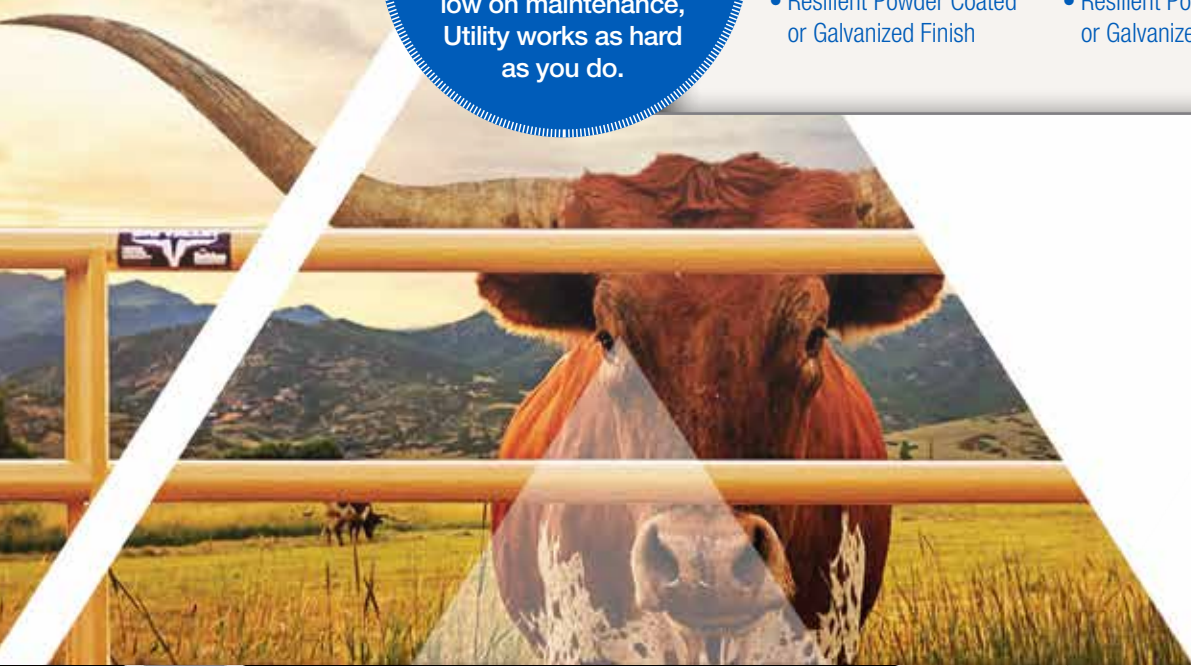
| | | | | |
|------------------|---|--|---|--------------------|
| <p>HD</p> | <p>Designed to withstand the most damaging conditions, the Heavy-Duty collection features 3 finishes, heavy gauge steel tubing, special Z-braces, and saddle weld joints, so you can count on them to last.</p> | <p>Gates</p> <ul style="list-style-type: none"> • Rugged 2" dia. tube • Hefty 14 or 16 gauge steel • Powder Coat, Galvanized or Hot-Dipped Galvanized Finish | <p>Corral Panels</p> <ul style="list-style-type: none"> • Rugged 2" dia. tube • Hefty 16 & 18 gauge steel • Powder Coat, Galvanized or Hot-Dipped Galvanized Finish • Heavy-duty 2" diameter arch gates, entrance panels and inverted arches | <p>Heavy-Duty</p> |
| <p>MD</p> | <p>Our Medium-Duty lineup is great for 365-day wear and tear. Armed with tough materials and durable finishes, Medium-Duty thrives in heavy traffic and bad weather.</p> | <p>Gates</p> <ul style="list-style-type: none"> • Rugged 1-5/8" dia. tube • Heavy 16 & 18 gauge steel • Resilient Powder Coated or Galvanized Finish | <p>Corral Panels</p> <ul style="list-style-type: none"> • Rugged 2" & 1-5/8" dia. tube • 16 & 18 gauge steel • Powder Coat or Galvanized Finish • Medium-duty 1-5/8" dia. entrance panels & arch gates | <p>Medium-Duty</p> |
| <p>U</p> | <p>For everyday performance that will last, and last, the Utility lineup is made for the job. Big on value, and low on maintenance, Utility works as hard as you do.</p> | <p>Gates</p> <ul style="list-style-type: none"> • Utility 1-5/8" dia. tubes • Utility 20 gauge steel • Resilient Powder Coated or Galvanized Finish | <p>Corral Panels</p> <ul style="list-style-type: none"> • Utility 1-5/8" dia. tube • Utility 18/20 gauge steel • Resilient Powder Coated or Galvanized Finish | <p>Utility</p> |

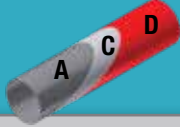

Gate & Corral Panel Finishes

|  | |  PREMIUM POWDER COAT |  HOT-DIPPED GALVANIZED |  GALVANIZED |
|---|---|---|---|---|
| A | Automotive grade, high tensile steel | ✘ | ✘ | |
| B | Automotive grade, high tensile, pre-galvanized steel | | | ✘ |
| C | State-of-the-art wash system 1) Alkaline cleaner removes oils, soils, etc. 2) De-greasing Rinse 3) Phosphate preps material for adhesion & corrosion resistance 4) Reverse osmosis rinse | ✘ | | |
| D | Behlen Country® Premium Powder Coat Paint <ul style="list-style-type: none"> • Electrostatically applied, ensures no runs and even coverage • 375° baked-on finish is hard as nails • UV resistant (fade resistant) • Similar to the process used in the automotive and appliance industry | ✘ | | |
| E | Behlen Country® exclusive on-site Hot-Dip Galvanizing <ul style="list-style-type: none"> • Increased life due to zinc coating on the inside as well as the outside of product • Provides the ultimate protection against corrosion and insures a lasting finish • For example: a 16' 2" gate has over 7 pounds of zinc applied over automotive grade, high tensile steel | | ✘ | |
| F | All welds are coated with zinc rich paint for increased protection | | | ✘ |



2" • 16 Ga. Gate

Heavy-Duty Gate 



RED



GREEN

Heavy-Duty Gate designed for crowding livestock areas. Horizontal tubes are notched and welded for additional strength. Finished with our premium powder coat paint. 3/4" x 12" bolt hooks.



| L (FT) | TUBE (IN) | HT (IN) | WT (LB) | VERT. 'Z' BRACES | RED ITEM # | GREEN ITEM # |
|--------------------------------------|-----------|---------|---------|------------------|------------|--------------|
| 2" • 16 GAUGE HEAVY-DUTY GATE | | | | | | |
| 4 | 2 | 50 | 41 | 0 | 40120041 | 40120042 |
| 6 | 2 | 50 | 55 | 0 | 40120061 | 40120062 |
| 8 | 2 | 50 | 72 | 1 | 40120081 | 40120082 |
| 10 | 2 | 50 | 87 | 1 | 40120101 | 40120102 |
| 12 | 2 | 50 | 100 | 1 | 40120121 | 40120122 |
| 14 | 2 | 50 | 118 | 2 | 40120141 | 40120142 |
| 16 | 2 | 50 | 133 | 2 | 40120161 | 40120162 |
| 18 | 2 | 50 | 152 | 3 | 40120181 | 40120182 |
| 20 | 2 | 50 | 167 | 3 | 40120201 | 40120202 |

2" • 16 Ga. Champion Gate

Heavy-Duty Gate 



YELLOW

Limited Lifetime Warranty

Champion Gates are designed with heavier vertical braces for extra strength and support. Finished with our premium powder coat paint and has an extra heavy chain latch with 36" chain. Visit behlencountry.com for warranty details.

NOTE: Hinges not included.

Hinge Item # 2208075

3 Hinges are recommended for 18' & 20'



| L (FT) | TUBE (IN) | HT (IN) | WT (LB) | VERT. 'Z' BRACES | YELLOW ITEM # |
|------------------------------------|-----------|---------|---------|------------------|---------------|
| 2" • 16 GAUGE CHAMPION GATE | | | | | |
| 4 | 2 | 50 | 42 | 0 | 40150046 |
| 6 | 2 | 50 | 58 | 0 | 40150066 |
| 8 | 2 | 50 | 80 | 1 | 40150086 |
| 10 | 2 | 50 | 97 | 1 | 40150106 |
| 12 | 2 | 50 | 113 | 1 | 40150126 |
| 14 | 2 | 50 | 134 | 2 | 40150146 |
| 16 | 2 | 50 | 151 | 2 | 40150166 |
| 18 | 2 | 50 | 172 | 3 | 40150186 |
| 20 | 2 | 50 | 188 | 3 | 40150206 |

Note: All gates are 4" less than listed length to allow for gate hardware and proper clearance.

2" • 16 Ga. Gate

Hog Gate



● RED

Designed for crowding in livestock areas. Horizontal tubes are notched and welded for additional strength. Finished with our red premium powder coat paint. Hog gate is 38" tall. 3/4" x 12" bolt hooks.

*Not available in West Region.



| L (FT) | TUBE (IN) | HT (IN) | WT (LB) | VERT. 'Z' BRACES | RED ITEM # |
|-------------------------------|-----------|---------|---------|------------------|------------|
| 2" • 16 GAUGE HOG GATE | | | | | |
| 10 | 2 | 38 | 83 | 1 | 40121101 |
| 12 | 2 | 38 | 98 | 1 | 40121121 |
| 16 | 2 | 38 | 130 | 2 | 40121161 |

2" • 16 Ga. Gate

Collared Hinge Gate



● GREEN

Heavy-Duty Gate designed for crowding livestock areas with square corners and collared hinges. Horizontal tubes are notched and welded for extra strength. Finished with our premium powder coat paint.



| L (FT) | TUBE (IN) | HT (IN) | WT (LB) | VERT. 'Z' BRACES | GREEN ITEM # |
|--|-----------|---------|---------|------------------|--------------|
| 2" • 16 GAUGE COLLARED HINGE GATE | | | | | |
| 4 | 2 | 50 | 45 | 0 | 40162042 |
| 6 | 2 | 50 | 59 | 0 | 40162062 |
| 8 | 2 | 50 | 76 | 1 | 40162082 |
| 10 | 2 | 50 | 90 | 1 | 40162102 |
| 12 | 2 | 50 | 104 | 1 | 40162122 |
| 14 | 2 | 50 | 122 | 2 | 40162142 |
| 16 | 2 | 50 | 136 | 2 | 40162162 |

2" • 16 Ga. Gate

Hot-Dipped Galvanized Gate



● HOT-DIPPED GALVANIZED

Hot-Dipped Galvanized Heavy-duty gate designed for crowding livestock areas with square corners for increased animal protection. Finished in a hot-dipped galvanized solution for long lasting performance and protection.

3/4" x 12" bolt hooks.



| L (FT) | TUBE (IN) | HT (IN) | WT (LB) | VERT. BRACES | HOT-DIPPED GALV ITEM # |
|---|-----------|---------|---------|--------------|------------------------|
| 2" • 16 GAUGE HOT-DIPPED GALVANIZED GATE | | | | | |
| 4 | 2 | 50 | 47 | 0 | 40129049 |
| 6 | 2 | 50 | 62 | 0 | 40129069 |
| 8 | 2 | 50 | 80 | 1 | 40129089 |
| 10 | 2 | 50 | 95 | 1 | 40129109 |
| 12 | 2 | 50 | 111 | 1 | 40129129 |
| 14 | 2 | 50 | 131 | 2 | 40129149 |
| 16 | 2 | 50 | 149 | 2 | 40129169 |

Note: All gates are 4" less than listed length to allow for gate hardware and proper clearance.

NOTE: Colors pictured may vary from actual product.

2" • 16 Ga. Gate

Heavy-Duty 2"x 4" Mesh Gate

Heavier than our standard wire-filled gate, our Heavy-Duty Mesh Gates are filled with the same rugged 2" x 4" mesh with heavier gauge 2" tube frame. This is the heaviest mesh gate available and constructed for more rugged use than the standard wire-filled gate. Finished with our premium powder coat paint. 3/4" x 12" bolt hooks.



| L (FT) | TUBE (IN) | HT (IN) | WT (LB) | VERT. BRACES | GREEN ITEM # |
|--|-----------|---------|---------|--------------|--------------|
| 2" • 16 GAUGE Heavy-duty WIRE-FILLED GATE | | | | | |
| 4 | 2 | 50 | 39 | 0 | 40135042 |
| 6 | 2 | 50 | 50 | 0 | 40135062 |
| 8 | 2 | 50 | 67 | 1 | 40135082 |
| 10 | 2 | 50 | 79 | 1 | 40135102 |
| 12 | 2 | 50 | 90 | 1 | 40135122 |
| 14 | 2 | 50 | 106 | 2 | 40135142 |
| 16 | 2 | 50 | 119 | 2 | 40135162 |



Wire-Filled Gate

2"x 4" Mesh Gate

Painted or Galvanized Finish

The Wire-filled Gates are filled with 2" x 4" mesh and are ideal for yards, confinement of small animals, or as a non-climb horse gate. Available finished in premium powder coat paint or galvanized finished for increased protection. 5/8" x 6" screw hooks.

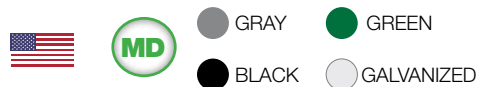

| L (FT) | TUBE (IN) | HT (IN) | WT (LB) | VERT. BRACES | GALV ITEM # | GRAY ITEM # | GREEN ITEM # | BLACK ITEM # |
|--|-----------|---------|---------|--------------|-------------|-------------|--------------|--------------|
| PAINTED MEDIUM-DUTY WIRE-FILLED GATE | | | | | | | | |
| 3 | 1.625 | 50 | 18 | 0 | - | 40132037 | 40132032 | 40132035 |
| 4 | 1.625 | 50 | 22 | 0 | - | 40132047 | 40132042 | 40132045 |
| 6 | 1.625 | 50 | 29 | 0 | - | 40132067 | 40132062 | 40132065 |
| 8 | 1.625 | 50 | 40 | 1 | - | 40132087 | 40132082 | 40132085 |
| 10 | 1.625 | 50 | 48 | 1 | - | 40132107 | 40132102 | 40132105 |
| 12 | 1.625 | 50 | 56 | 1 | - | 40132127 | 40132122 | 40132125 |
| 14 | 1.625 | 50 | 63 | 2 | - | 40132147 | 40132142 | 40132145 |
| 16 | 1.625 | 50 | 74 | 2 | - | 40132167 | 40132162 | 40132165 |
| GALVANIZED MEDIUM-DUTY WIRE-FILLED GATE | | | | | | | | |
| 3 | 1.625 | 50 | 20 | 0 | 40183038 | - | - | - |
| 4 | 1.625 | 50 | 24 | 0 | 40183048 | - | - | - |
| 6 | 1.625 | 50 | 32 | 0 | 40183068 | - | - | - |
| 8 | 1.625 | 50 | 43 | 1 | 40183088 | - | - | - |
| 10 | 1.625 | 50 | 52 | 1 | 40183108 | - | - | - |
| 12 | 1.625 | 50 | 60 | 1 | 40183128 | - | - | - |
| 14 | 1.625 | 50 | 69 | 2 | 40183148 | - | - | - |
| 16 | 1.625 | 50 | 79 | 2 | 40183168 | - | - | - |

Note: All gates are 4" less than listed length to allow for gate hardware and proper clearance.

Heaviest Mesh Gate in the Industry!

Hog Mesh Gate GALVANIZED

The Hog Mesh Gate is galvanized for long life. The 6 gauge mesh woven in a "hog" pattern is 40% heavier than the competition! Features variable spacing in the mesh which is best for small animals. Bolt-on hinges allow gate to be easily reversed when hanging two gates together. Square corner. 5/8" x 6" screw hooks.



| L (FT) | TUBE (IN) | HT (IN) | WT (LB) | VERT. BRACES | GALVANIZED ITEM # |
|----------------------|-----------|---------|---------|--------------|-------------------|
| HOG MESH GATE | | | | | |
| 4 | 1.625 | 50 | 20 | 0 | 40115048 |
| 6 | 1.625 | 50 | 24 | 0 | 40115068 |
| 8 | 1.625 | 50 | 36 | 1 | 40115088 |
| 10 | 1.625 | 50 | 42 | 1 | 40115108 |
| 12 | 1.625 | 50 | 49 | 1 | 40115128 |
| 14 | 1.625 | 50 | 58 | 2 | 40115148 |
| 16 | 1.625 | 50 | 64 | 2 | 40115168 |
| 18 | 1.625 | 50 | 73 | 3 | 40115188 |

Deer/Wildlife Gate GALVANIZED

The Deer/Wildlife Gates are designed to keep deer, elk, and other wildlife out of your fields. This 84" tall gate is galvanized for long life and has three bolt and hook hinges that make the gate reversible for any application. The tubular and mesh design is perfect for keeping unwanted animals out of designated areas. 5/8" x 12" bolt hooks.

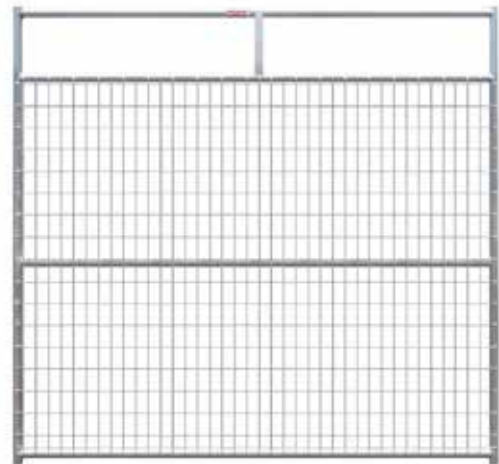

| L (FT) | TUBE (IN) | HT (IN) | WT (LB) | VERT. BRACES | GALVANIZED ITEM # |
|---------------------------|-----------|---------|---------|--------------|-------------------|
| DEER/WILDLIFE GATE | | | | | |
| 4 | 1.625 | 84 | 56 | - | 40107048 |
| 8 | 1.625 | 84 | 96 | - | 40107088 |
| 10 | 1.625 | 84 | 114 | - | 40107108 |
| 12 | 1.625 | 84 | 132 | - | 40107128 |

Note: All gates are 4" less than listed length to allow for gate hardware and proper clearance.

Medium-Duty Gate

Collared Hinge Gate GREEN

The collared hinge medium-duty gate has 6 rails and is 50" tall. Built with 16 gauge verticals and 20 gauge fill pipe for increased strength and durability. The vertical z-braces offer extra strength and support. Finished with long-lasting, UV resistant powder coat finish. Comes with plated chain and snap assembly.

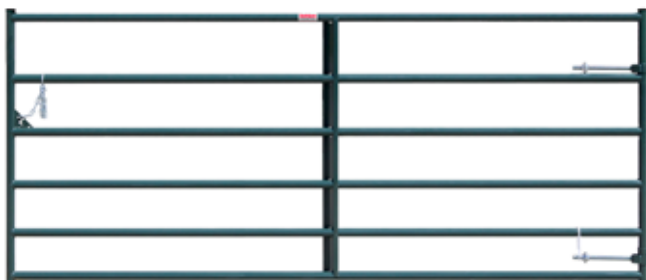

| L (FT) | TUBE (IN) | HT (IN) | WT (LB) | VERT. 'Z' BRACES | GREEN ITEM # |
|--|-----------|---------|---------|------------------|--------------|
| MEDIUM-DUTY SQUARE CORNER COLLARED HINGE GATE | | | | | |
| 4 | 1.625 | 50 | 30 | 0 | 40140042 |
| 6 | 1.625 | 50 | 37 | 0 | 40140062 |
| 8 | 1.625 | 50 | 46 | 1 | 40140082 |
| 10 | 1.625 | 50 | 54 | 1 | 40140102 |
| 12 | 1.625 | 50 | 64 | 2 | 40140122 |
| 14 | 1.625 | 50 | 72 | 2 | 40140142 |
| 16 | 1.625 | 50 | 81 | 3 | 40140162 |
| 18 | 1.625 | 50 | 89 | 3 | 40140182 |
| 20 | 1.625 | 50 | 97 | 3 | 40140202 |

NOTE: Colors pictured may vary from actual product.

7 Rail Gate RED GREEN GRAY BLACK GALVANIZED

The 7 Rail Gate features additional rails added at bottom of gate and spaced closer together for added animal safety. Finished with our premium powder coat paint. 5/8 x 12" bolt hooks.

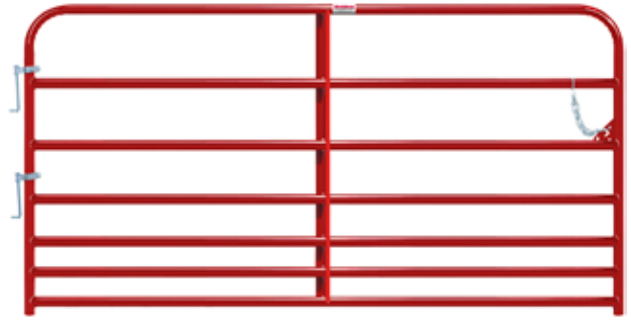

Note: Black & Galvanized 7 Rail Gates are not available in the West Region

| L (FT) | TUBE (IN) | HT (IN) | WT (LB) | VERT. 'Z' BRACES | RED ITEM# | GREEN ITEM # | BLACK ITEM # | GRAY ITEM # | GALV ITEM # |
|--------------------|-----------|---------|---------|------------------|-----------|--------------|--------------|-------------|-------------|
| 7 RAIL GATE | | | | | | | | | |
| 4 | 1.625 | 50 | 27 | 0 | 40169041 | 40169042 | 40169045 | 40169047 | 40175048 |
| 6 | 1.625 | 50 | 38 | 0 | 40169061 | 40169062 | 40169065 | 40169067 | 40175068 |
| 8 | 1.625 | 50 | 46 | 1 | 40169081 | 40169082 | 40169085 | 40169087 | 40175088 |
| 10 | 1.625 | 50 | 58 | 2 | 40169101 | 40169102 | 40169105 | 40169107 | 40175108 |
| 12 | 1.625 | 50 | 66 | 2 | 40169121 | 40169122 | 40169125 | 40169127 | 40175128 |
| 14 | 1.625 | 50 | 74 | 3 | 40169141 | 40169142 | 40169145 | 40169147 | 40175148 |
| 16 | 1.625 | 50 | 84 | 3 | 40169161 | 40169162 | 40169165 | 40169167 | 40175168 |
| 18 | 1.625 | 50 | 95 | 3 | 40169181 | 40169182 | 40169185 | 40169187 | - |
| 20 | 1.625 | 50 | 104 | 3 | 40169201 | 40169202 | 40169205 | 40169207 | - |

18' & 20'
Are Back!

Landowner Gate GREEN

Landowner Gate visibility is ensured both day and night with reflective decals. Telescopes 12'-20' to fit most openings and accepts most padlocks (not included). Heavy collared hinge keeps gate from sagging, and makes theft or removal of gate difficult. Constructed with 2" 18 ga. high tensile strength steel.

- Extends 12'-20'
- WT 33 lb

Item # 40100122



Galvanized Gate GALVANIZED

Ideal for non-crowding applications such as pastures, field entrances, and coastal or corrosive areas. Gates have galvanized finish with welded latch and plated chain included. 5/8" x 6" screw hooks.



| L (FT) | TUBE (IN) | HT (IN) | WT (LB) | VERT. 'Z' BRACES | GALVANIZED ITEM # |
|-------------------------------|-----------|---------|---------|------------------|-------------------|
| GALVANIZED GATE 6 RAIL | | | | | |
| 4 | 1.625 | 50 | 20 | 0 | 40113048 |
| 6 | 1.625 | 50 | 28 | 0 | 40113068 |
| 8 | 1.625 | 50 | 37 | 1 | 40113088 |
| 10 | 1.625 | 50 | 44 | 1 | 40113108 |
| 12 | 1.625 | 50 | 50 | 1 | 40113128 |
| 14 | 1.625 | 50 | 60 | 2 | 40113148 |
| 16 | 1.625 | 50 | 67 | 2 | 40113168 |
| 18 | 1.625 | 50 | 77 | 3 | 40113188 |

Note: All gates are 4" less than listed length to allow for gate hardware and proper clearance.

Utility Gate

Our Best Selling Gate!

Designed for tame animals, entrances to pastures and driveways. Combines low cost and great features. Finished with our premium powder coated paint. 5/8" x 6" screw hooks.



Utility Gates Available in Round or Square Corners



RED



GRAY



GREEN



BLACK



| L (FT) | TUBE (IN) | HT (IN) | WT (LB) | VERT. 'Z' BRACES | RED ITEM # | GREEN ITEM # | GRAY ITEM # | BLACK ITEM # |
|----------------------|-----------|---------|---------|------------------|------------|--------------|-------------|--------------|
| ROUND CORNER | | | | | | | | |
| 4 | 1.625 | 50 | 19 | 0 | 40130041 | 40130042 | 40130047 | 40130045 |
| 6 | 1.625 | 50 | 26 | 0 | 40130061 | 40130062 | 40130067 | 40130065 |
| 8 | 1.625 | 50 | 34 | 1 | 40130081 | 40130082 | 40130087 | 40130085 |
| 10 | 1.625 | 50 | 42 | 1 | 40130101 | 40130102 | 40130107 | 40130105 |
| 12 | 1.625 | 50 | 49 | 1 | 40130121 | 40130122 | 40130127 | 40130125 |
| 14 | 1.625 | 50 | 55 | 2 | 40130141 | 40130142 | 40130147 | 40130145 |
| 16 | 1.625 | 50 | 63 | 2 | 40130161 | 40130162 | 40130167 | 40130165 |
| 18 | 1.625 | 50 | 72 | 3 | 40130181 | 40130182 | 40130187 | 40130185 |
| SQUARE CORNER | | | | | | | | |
| 4 | 1.625 | 50 | 19 | 0 | - | 40136042 | 40136047 | 40136045 |
| 6 | 1.625 | 50 | 26 | 0 | - | 40136062 | 40136067 | 40136065 |
| 8 | 1.625 | 50 | 34 | 1 | - | 40136082 | 40136087 | 40136085 |
| 10 | 1.625 | 50 | 42 | 1 | - | 40136102 | 40136107 | 40136105 |
| 12 | 1.625 | 50 | 48 | 1 | - | 40136122 | 40136127 | 40136125 |
| 14 | 1.625 | 50 | 55 | 2 | - | 40136142 | 40136147 | 40136145 |
| 16 | 1.625 | 50 | 63 | 2 | - | 40136162 | 40136167 | 40136165 |

Note: All gates are 4" less than listed length to allow for gate hardware and proper clearance.

Gate Accessories



Bolt Hook - 1-5/8"

Replacement bolt hook for installation of 1-5/8" gates.

Item # 42900038

Weight 2 lb

0.625 x 12 inches



Bolt Hook - 2"

Replacement bolt hook for installation of 2" gates.

Item # 40300029

Weight 2 lb

0.75 x 12 inches



Screw Hook

Zinc plated screw hook for extra support of gates.

Item # 3208159

Weight 1 lb

0.625 x 6 inches



Heavy-duty Hinge

Heavy-duty two piece 2" hinge with bolt hook, compatible with all Behlen Country 2" gates.

Item # 2208075

Weight 4 lb



Hinge - 1-5/8"

Zinc plated hinge for all 1-5/8" gates. Includes hardware.

Item # 40113018

Weight .5 lb



Hinge - 2"

Zinc plated hinge for all 2" gates. Includes hardware.

Item # 40300019

Weight 1 lb



90° Corner Bracket

Used to attach gates to walls, accommodates 2" gates only.

Item # 40100037

Weight 2 lb



Flat Bracket

Used to attach gates to walls, accommodates 2" gates only.

Item # 40100047

Weight 2 lb



Hanging Clip - 1-5/8"

Allows for attaching a gate or corral panel to a post or flat surface.

Item # 35125195

Weight .25 lb



Hanging Clip - 2"

Allows for attaching a gate or corral panel to a post or flat surface.

Item # 35600295

Weight .25 lb



Horse Gate Latch

Allows gate to be opened from horseback, adjustable and reversible.

Item # 44112207

Weight 7 lb



Double Piston Lever Latch

Allows easy opening of gate from horseback. For 2" gates only.

Item # 44110132

Weight 16 lb



UPS shipping is available for items on this page.



Chain & Snap Assembly

Chain and Snap comes pre assembled and ready to use.

Item # 1488039

Weight .5 lb

Gate Hardware Packages

Behlen Country hardware packages are weatherproof and sun-resistant. No other livestock equipment manufacturer offers this easy-to-use, complete kit. Offer your customers something unique!

- High quality, rust-resistant, plated hardware compared to painted.
- Chain attached after fabrication which leaves the gate with the best possible finish. Chain is NOT welded to the gate which can leave a hole in the gate and a rusty spot for decreased life.
- No worries with installation as Behlen Country® includes gate installation instructions with every package.
- Strong, UV resistant covering on hardware packages for extended life.
- Easy identification for individual ordering with the large, easy-to-read barcode.



Package 1

Two 5/8" x 6" screw hooks, two 1-5/8" hinges, chain with snap and hardware.

Item # 40900158

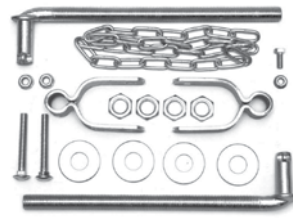

Package 2

Two 3/4" x 12" bolt hooks, two 2" hinges, chain and hardware.

Item # 40900108



Package 3

Three 3/4" x 12" bolt hooks, three 2" hinges, chain and hardware.

Item # 40900118

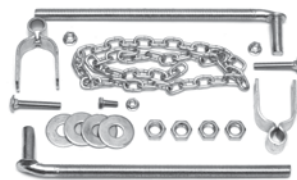

Package 4

Two 5/8" x 12" bolt hooks and two 1-5/8" hinges, chain and hardware.

Item # 40900198



Package 5

Three 5/8" x 6" screw hooks and three 1-5/8" hinges and chain assembly with snap.

Item # 40900208



UPS shipping is available for gate hardware packages.

NOTE: There is a minimum dollar amount for all UPS shipping orders. Please call us at 800-447-2751 or visit www.behlencountry.com for more information.

Gate Racks & Stands

Gate Stands

The peg style gate stand allows gates to be merchandised vertically, allowing customers to fully inspect and visualize gates in use. Gates can be stored on pegs for secure display or double the capacity by setting gates between pegs. Stand is finished with our premium Powder Coat Paint.



6 Peg Gate Stand (sold in pairs)

Item # 82100607

Weight 12 lb



15 Peg Gate Stand

Item # 82100610YEL

Weight 40 lb

Gate Rack

Display Rack designed with two levels for showcasing gates. May be anchored to concrete or asphalt. Holds up to 40 2" gates or kennels.

Item # 82100307

Weight 281 lb



Single Tier Rack

Display Rack designed with one level for showcasing gates. Can be anchored to concrete or asphalt. Holds up to 20 2" gates.

Item # 82100207

Weight 218 lb



NOTE: Colors pictured may vary from actual product.



How to calculate your round pen:

1.) To find the number of panels needed, multiply the desired diameter (straight line passing through the center of the circle) by 3.14. This will determine the circumference (the distance around the circle).

2.) Divide the circumference by the length of panels being used. This will equal the number of panels needed.

| | | ROUND PEN CHART | | | | | | | | | | | | | | | | |
|-----------|--|---------------------------------|-----|-----|-----|-----|-----|-----|-----|-----|-----|-----|-----|-----|-----|-----|-----|------|
| | | DIAMETER OF HOLDING AREA (FEET) | | | | | | | | | | | | | | | | |
| | | 20' | 25' | 30' | 35' | 40' | 45' | 50' | 55' | 60' | 65' | 70' | 75' | 80' | 85' | 90' | 95' | 100' |
| 10' PANEL | | 6 | 8 | 9 | 11 | 13 | 14 | 16 | 17 | 19 | 20 | 22 | 24 | 25 | 27 | 28 | 30 | 31 |
| 12' PANEL | | 5 | 7 | 8 | 9 | 10 | 12 | 13 | 14 | 15 | 17 | 18 | 20 | 21 | 22 | 24 | 25 | 26 |
| | | NUMBER OF PANELS NEEDED | | | | | | | | | | | | | | | | |

NOTE: SIZES ARE APPROXIMATE. QUANTITIES ABOVE INCLUDE ENTRANCE PANEL OF SAME LENGTH AS CORRAL PANEL. PEN DIAMETERS WILL VARY DEPENDING ON SIZE OF ENTRANCE PANEL OR ARCH GATE.



2" • 16 Ga. Panel

Heavy-Duty

XT Corral Panels | 6 Rail • 72" Tall

The XT Corral Panel is designed for training horses in round pens. Square corners and tight chain connections reduce space between panels (butterfly clamps are optional). Finished with either our premium powder coat paint or our long-lasting hot-dipped galvanized finish.



HOT-DIPPED GALVANIZED



GRAY

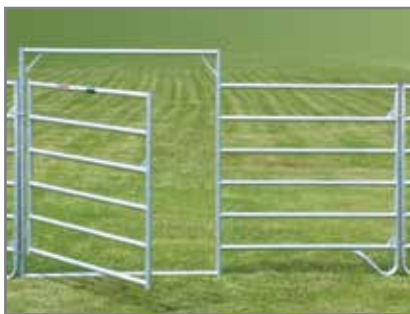

XT 12' Entrance Panel w/ 6' x 7' Arch Gate, finished with long-lasting hot-dipped galvanized finish.



XT 12' Entrance Panel w/ 6' x 7' Arch Gate, finished with premium powder coat paint.

| DESCRIPTION | LENGTH (FEET) | TUBE WIDTH (INCHES) | HEIGHT (INCHES) | WEIGHT (POUNDS) | VERT. BRACES | HOT-DIPPED GALV. ITEM # | GRAY ITEM # |
|--|---------------|---------------------|-----------------|-----------------|--------------|-------------------------|-------------|
| XT HOT-DIPPED GALVANIZED ITEMS | | | | | | | |
| XT Corral Panel | 12 | 2 | 72 | 96 | 1 | 44131129 | - |
| XT 6 x 9 Arch Gate | 6 | 2 | 108 | 86 | - | 44131019 | - |
| XT 12' Ent Pnl Arch w/ 6 x 7 Gate | 12 | 2 | 84 | 125 | - | 44131039 | - |
| XT GRAY POWDER COAT PAINT ITEMS | | | | | | | |
| XT Corral Panel | 12 | 2 | 72 | 92 | 1 | - | 44131127 |
| XT 6 x 9 Arch Gate | 6 | 2 | 108 | 84 | - | - | 44131017 |
| XT 12' Ent Pnl Arch w/ 6 x 7 Gate | 12 | 2 | 84 | 120 | - | - | 44131037 |

NOTE: Colors pictured may vary from actual product.

2" • 16 Ga. Panel

Heavy-Duty

Crowding Corral Panels | 66" Tall

The Crowding Corral panels are designed specifically for crowding situations with square corners, J-legs and pin hookups. These corral panels are built for rough use and include Pin Hookups for easy connection. Our unique J-leg design has a small contact point with the ground to prevent unwanted panel movement. Finished with our premium powder coat paint.



GREEN

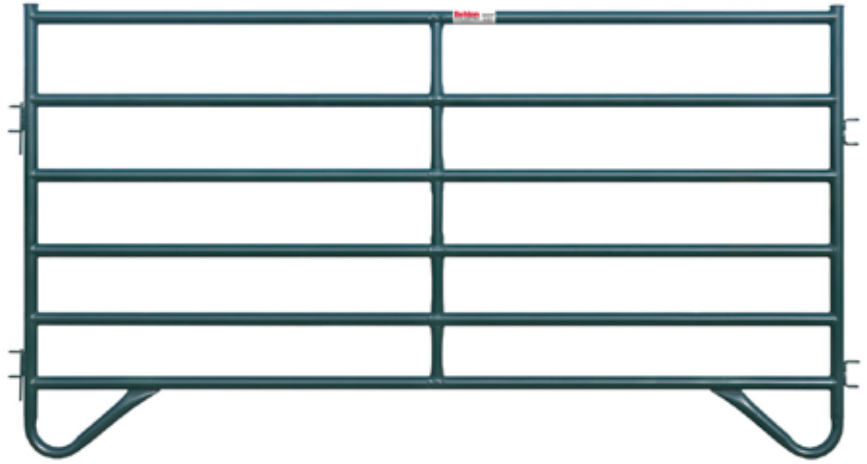

| LENGTH (FEET) | TUBE WIDTH (INCHES) | HEIGHT (INCHES) | WEIGHT (POUNDS) | VERT. BRACES | GREEN ITEM # |
|--|---------------------|-----------------|-----------------|--------------|--------------|
| 2" • 16 GAUGE CROWDING CORRAL PANEL | | | | | |
| 8 | 2 | 66 | 79 | 1 | 44123082 |
| 10 | 2 | 66 | 94 | 1 | 44123102 |
| 12 | 2 | 66 | 108 | 1 | 44123122 |
| 14 | 2 | 66 | 127 | 2 | 44123142 |
| 16 | 2 | 66 | 141 | 2 | 44123162 |
| 10' Ent. Pnl w/4' Gate | 2 | 84 | 115 | - | 44123022 |

Inverted Arch Panel

Heavy-Duty

Inverted Arch Panels are made of extra heavy, rectangular steel tubing and can be used with Behlen Country® Utility or Crowding Panels. Finished with our premium powder coat paint.



GREEN

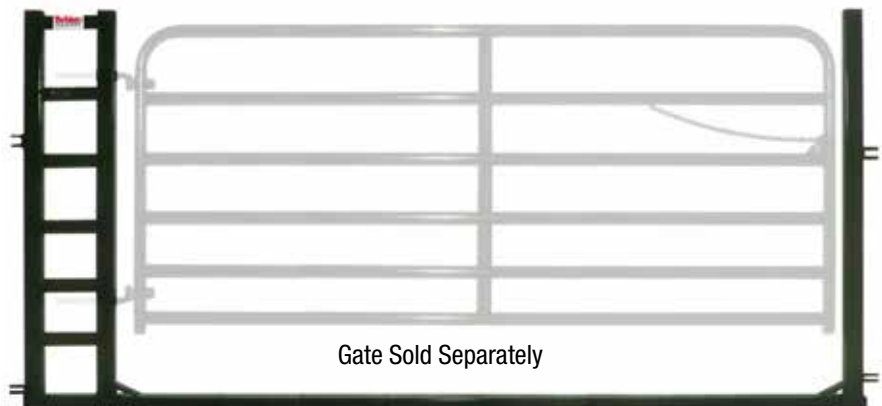

| LENGTH (FEET) | TUBE WIDTH (INCHES) | HEIGHT (INCHES) | WEIGHT (POUNDS) | VERT. BRACES | GREEN ITEM # |
|---|---------------------|-----------------|-----------------|--------------|--------------|
| INVERTED ARCH PANEL | | | | | |
| 10 | 2 | 66 | 130 | - | 40168102 |
| 12 | 2 | 66 | 141 | - | 40168122 |
| 2" 16 GAUGE GATES (Suitable to use with Inverted Arch Panel) | | | | | |
| 8 | 2 | 50 | 72 | 1 | 40120082 |
| 10 | 2 | 50 | 86 | 1 | 40120102 |

Note: It is recommended that the 2" 16 ga. gate be used with the inverted arch. Gates used with inverted arches are to be ordered the next size smaller than the arch gate. Example: 10' inverted arch will use an 8' gate.

Behlen Country's Best Value for the Cattle Producer

Medium-Duty Corral Panel

The Medium-Duty Corral Panels are designed with square corners, J-legs and pin hookups. These corral panels are built for rough use and include Pin Hookups for easy connection. Our unique J-leg design has a small contact point with the ground to prevent unwanted panel movement. Premium powder coat paint finish.



Pin Hookup

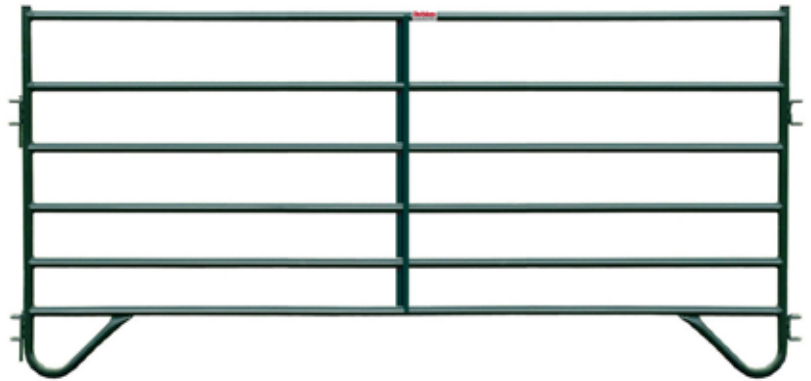

GREEN



RED

| LENGTH (FEET) | TUBE WIDTH (INCHES) | HEIGHT (INCHES) | WEIGHT (POUNDS) | VERT. BRACES | RED ITEM # | GREEN ITEM # |
|---------------------------------|---------------------|-----------------|-----------------|--------------|------------|--------------|
| MEDIUM-DUTY CORRAL PANEL | | | | | | |
| 8 | 1.625 | 60 | 62 | 1 | 44120081 | 44120082 |
| 10 | 1.625 | 60 | 73 | 1 | 44120101 | 44120102 |
| 12 | 1.625 | 60 | 84 | 1 | 44120121 | 44120122 |
| 14 | 1.625 | 60 | 106 | 2 | 44120141 | 44120142 |
| 16 | 1.625 | 60 | 119 | 2 | 44120161 | 44120162 |
| 4 x 7 Arch Gate | 1.625 | 84 | 54 | - | 44120181 | 44120182 |
| 10' Ent. Panel w/4' Gate | 1.625 | 84 | 93 | - | 44120201 | 44120202 |
| 12' Ent. Panel w/4' Gate | 1.625 | 84 | 106 | - | 44120221 | 44120222 |

Custom Livestock Pens

Behlen Country Custom Livestock Pens are the perfect solution for animal containment at livestock shows, fair grounds, and equine facilities.

Bid projects only, please call for quote 800-447-2751.

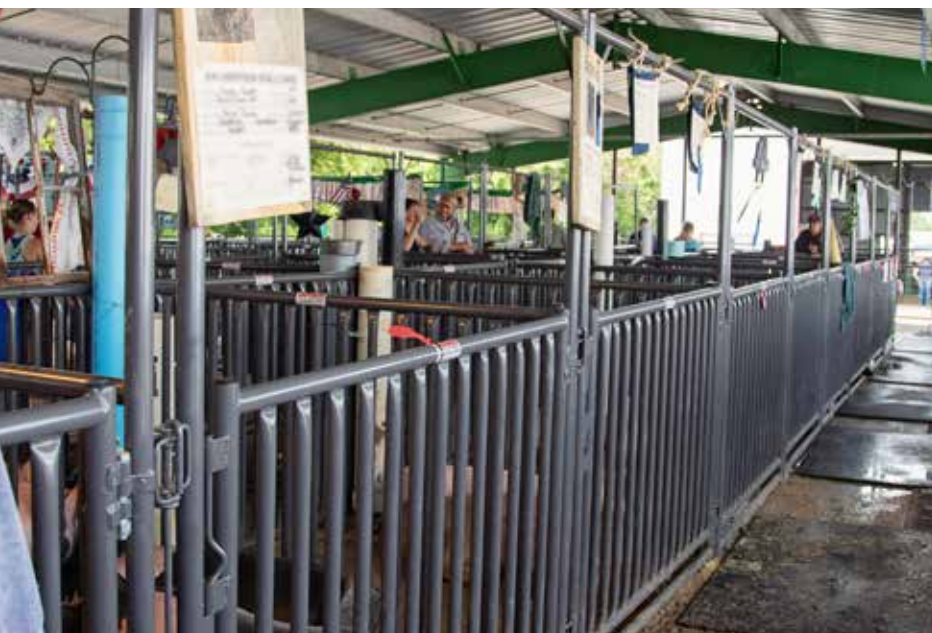

| DESCRIPTION | HT (IN) | WT (LB) | GRAY ITEM # |
|----------------------|---------|---------|-------------|
| 4' Fair Panel w/Gate | 41 | 67 | 74122817 |
| 5' Fair Panel w/Gate | 41 | 77 | 74122777 |
| 6' Fair Panel w/Gate | 41 | 91 | 74122707 |
| 4' Fair Panel | 41 | 46 | 74122787 |
| 5' Fair Panel | 41 | 56 | 74122747 |
| 6' Fair Panel | 41 | 67 | 74122737 |
| 10' Fair Panel | 41 | 99 | 74122697 |
| 4' Fair Panel w/Gate | 49 | 76 | 74122517 |
| 5' Fair Panel w/Gate | 49 | 86 | 74122477 |
| 6' Fair Panel w/Gate | 49 | 100 | 74122407 |
| 4' Fair Panel | 49 | 54 | 74122487 |
| 5' Fair Panel | 49 | 66 | 74122447 |
| 6' Fair Panel | 49 | 79 | 74122437 |
| 10' Fair Panel | 49 | 119 | 74122397 |

NOTE: Colors pictured may vary from actual product.

Horse Country Panel

Pin Hook-Up or Chain Hook-Up

The Horse Country Panel is designed specifically for horse owners. It is taller and heavier than our standard utility panel. Our unique J-leg design has a small contact point with ground to prevent unwanted panel movement. Finished with our premium powder coat paint.



GRAY



GREEN



Galvanized Utility Panel

64" Tall, Pin or Chain Hook-Up

The Galvanized Utility Corral Panels combine lower cost with great features. Great value in a corral panel; portable and easy to hook up on uneven ground with pin or chain hook-ups. Galvanized finish for increased rust protection and longer life.



GALVANIZED



| DESCRIPTION L (FT) | TUBE (IN) | HT (IN) | WT (LB) | VERT. BRACES | GRAY ITEM # | GREEN ITEM # | GALV. ITEM # |
|-----------------------|--------------|------------|------------|-----------------|----------------|-----------------|-----------------|
|-----------------------|--------------|------------|------------|-----------------|----------------|-----------------|-----------------|

HORSE COUNTRY CORRAL PANEL - PIN HOOK-UPS

| | | | | | | | |
|--|-------|-----|----|---|----------|----------|---|
| 10 | 1.625 | 64 | 54 | 1 | 44144107 | 44144102 | - |
| 12 | 1.625 | 64 | 64 | 2 | 44144127 | 44144122 | - |
| 16 | 1.625 | 64 | 83 | 3 | 44144167 | 44144162 | - |
| 6' x 9' Arch Gate | 1.625 | 108 | 57 | - | 44144017 | 44144012 | - |
| 10' Ent. Panel w/ 6' x 7' Arch Gate | 1.625 | 84 | 70 | - | 44144027 | 44144022 | - |
| 12' Ent. Panel w/ 6' x 7' Arch Gate | 1.625 | 84 | 80 | - | 44144037 | 44144032 | - |

HORSE COUNTRY CORRAL PANEL - CHAIN HOOK-UPS

| | | | | | | | |
|--|-------|-----|----|---|----------|----------|---|
| 10 | 1.625 | 64 | 53 | 1 | 44146107 | 44146102 | - |
| 12 | 1.625 | 64 | 64 | 2 | 44146127 | 44146122 | - |
| 16 | 1.625 | 64 | 82 | 3 | 44146167 | 44146162 | - |
| 6' x 9' Arch Gate | 1.625 | 108 | 56 | - | 44146017 | 44146012 | - |
| 10' Ent. Panel w/ 6' x 7' Arch Gate | 1.625 | 84 | 75 | - | 44146027 | 44146022 | - |
| 12' Ent. Panel w/ 6' x 7' Arch Gate | 1.625 | 84 | 83 | - | 44146037 | 44146032 | - |

GALVANIZED UTILITY CORRAL PANEL - PIN HOOK-UPS

| | | | | | | | |
|---------------------------------------|-------|-----|----|---|---|---|----------|
| 12 | 1.625 | 64 | 62 | 1 | - | - | 44142128 |
| 6' x 9' Arch Gate | 1.625 | 108 | 60 | - | - | - | 44142018 |
| 12' Ent. Panel w 6' x 7' Arch Gate | 1.625 | 84 | 82 | - | - | - | 44142038 |

GALVANIZED UTILITY CORRAL PANEL - CHAIN HOOK-UPS

| | | | | | | | |
|--|-------|-----|----|---|---|---|----------|
| 12 | 1.625 | 64 | 61 | 1 | - | - | 44127128 |
| 6' x 9' Arch Gate | 1.625 | 108 | 60 | - | - | - | 44127028 |
| 12' Ent. Panel w/ 6' x 7' Arch Gate | 1.625 | 84 | 82 | - | - | - | 44127038 |

Utility Corral Panel

60" Tall, 6 Rail, Pin Hook-Up

The Utility Corral Panels combine lower cost with great features. Great value in a corral panel; portable and easy to hook-up on uneven ground with Pin hook-ups. Finished with our premium powder coat paint.



RED



GRAY



GREEN

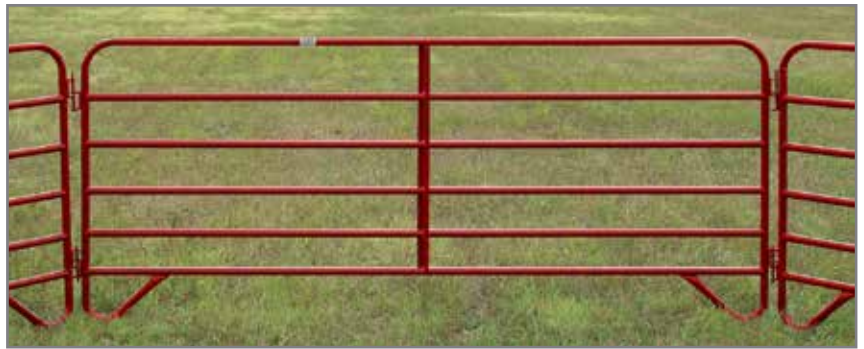

Available in Round and Square Corners!

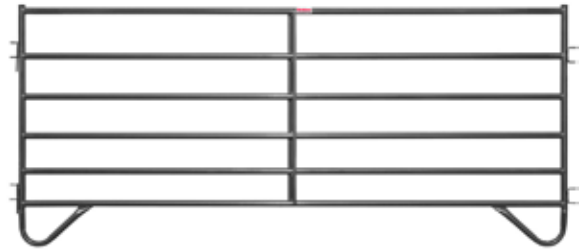

| LENGTH (FEET) | TUBE WIDTH (INCHES) | HEIGHT (INCHES) | WEIGHT (POUNDS) | VERT. BRACES | RED ITEM # | GREEN ITEM # | GRAY ITEM # |
|---|---------------------|-----------------|-----------------|--------------|------------|--------------|-------------|
| UTILITY CORRAL PANEL - ROUND CORNER | | | | | | | |
| 10 | 1.625 | 60 | 46 | 1 | 44121101 | 44121102 | 44121107 |
| 12 | 1.625 | 60 | 52 | 1 | 44121121 | 44121122 | 44121127 |
| 16 | 1.625 | 60 | 67 | 2 | 44121161 | 44121162 | 44121167 |
| 4' x 8' Arch Gate | 1.625 | 96 | 56 | - | 44121181 | 44121182 | 44121187 |
| 6' x 9' Arch Gate | 1.625 | 108 | 57 | - | 44121011 | 44121012 | 44121017 |
| 12' Ent. Panel w/6' x 7' Arch Gate | 1.625 | 84 | 76 | - | 44121031 | 44121032 | 44121037 |
| UTILITY CORRAL PANEL - SQUARE CORNER | | | | | | | |
| 10 | 1.625 | 60 | 46 | 1 | - | 44122102 | 44122107 |
| 12 | 1.625 | 60 | 52 | 1 | - | 44122122 | 44122127 |
| 16 | 1.625 | 60 | 66 | 2 | - | 44122162 | 44122167 |
| 6' x 9' Arch Gate | 1.625 | 108 | 60 | - | - | 44122012 | 44122017 |

Kidding Pen

Kidding Pens offer easy assembly for portability and are ideal for confinement at shows and fairs. Several size panels allow for multiple configurations.



| DESCRIPTION | TUBE (IN) | HT (IN) | WT (LB) | GRAY ITEM # |
|-------------------------------|-----------|---------|---------|-------------|
| A. 5' x 7'-9" Arch Gate Panel | 1.625 | 48 | 67 | 74123017 |
| B. 5' Panel | 1.625 | 48 | 29 | 74123057 |
| C. 8' Panel | 1.625 | 48 | 47 | 74123087 |
| D. 10' Panel | 1.625 | 48 | 55 | 74123107 |

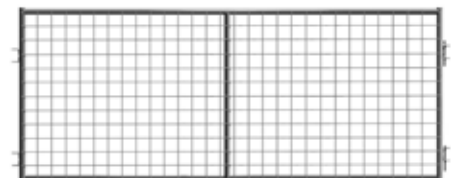
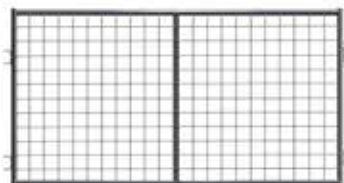
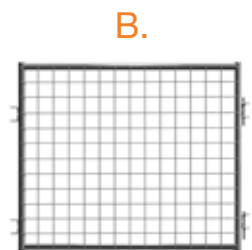
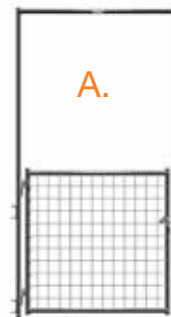

C.

D.

NOTE: Colors pictured may vary from actual product.

Panel Accessories



Corral to Wall Panel Hook-up (Male)

Allows corral panels to be attached to a flat wall.

Item # 44110407

Weight 3 lb



Corral to Wall Panel Hook-up (Female)

Allows corral panels to be attached to a flat wall.

Item # 44110417

Weight 2 lb



Galvanized Butterfly Clamps for 1-5/8" Tubing

Galvanized clamps add more stability and strength to corral panels with standard chain hook-ups. 2 pair.

Item # 38900069

Weight 2 lb



Painted Butterfly Clamps for 1-5/8" Tubing

Painted clamps add more stability and strength to corral panels with standard chain hook-ups. 2 pair.

Item # 38900067

Weight 2 lb

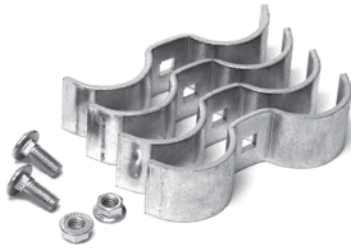

Galvanized Butterfly Clamps for 2" Tubing

Galvanized clamps add more stability and strength to corral panels with standard chain hook-ups. 2 pair.

Item # 44900069

Weight 2 lb



Painted Butterfly Clamps for 2" Tubing

Painted clamps add more stability and strength to corral panels with standard chain hook-ups. 2 pair.

Item # 44900067

Weight 2 lb



Chain Hardware Package

Used to fasten panels with chains. Bolt and nut included. 1 Chain.

Item # 44900100

Weight 1 lb



Chain Hardware Package

Used to fasten panels with chains. Bolts and nuts included. 2 Chains.

Item # 44900090

Weight 3 lb



Corral Adapter Rod

Used as a drop pin for hooking uncommon pin hookup corral panels together. Heavy 9/16" diameter rod will take rugged abuse.

Item # 44110309

Weight 4 lb



1 5/8" Plastic Cap for Gates or Panels

This 1 5/8" plug fits all Behlen Country gates and corral panels.

Item # 1448107

Weight .02 lb



2" Plastic Cap for Gates or Panels

This 2" plug fits all Behlen Country gates and corral panels.

Item # 1448108

Weight .02 lb



UPS shipping is available for items on this page.

Longest lasting Fence Panels on the Market!

- All panels are **hot-dip galvanized** after welding so all weld spots are completely covered, eliminating rust and corrosion at all "shear" points and joints.
- Zinc dramatically increases fence life, eliminates rust and reduces rod separation.
- Hot-dipped galvanized delivers more than 3 times the protection of pre-galvanized rod.
- Available in a wide range of sizes for various applications.



WARRANTY NOTE: Fence Panels have a **FIVE-YEAR WARRANTY**.

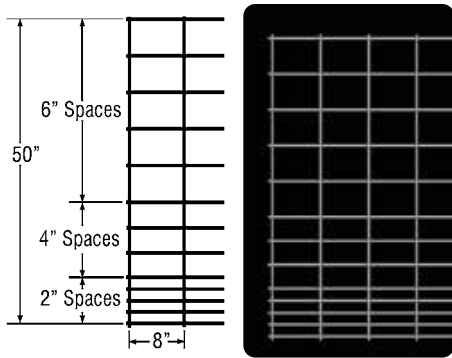

50" Combo 
Item # 33150999

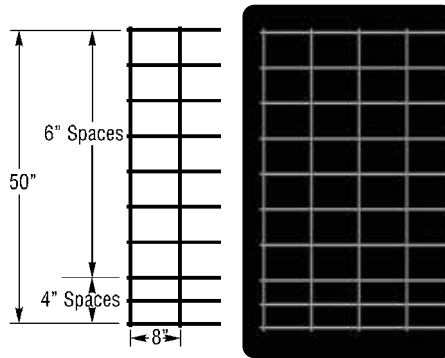

50" Cattle 
Item # 33150739

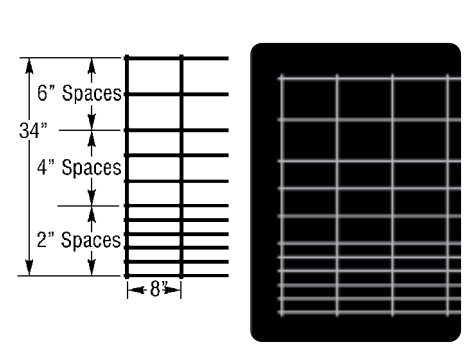

34" Hog 
Item # 33150979

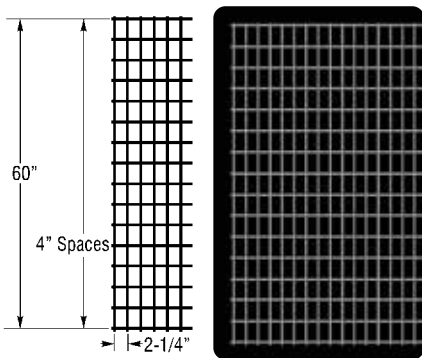

60" Horse Security 
16' Item # 33150759, 8' Item #33150659

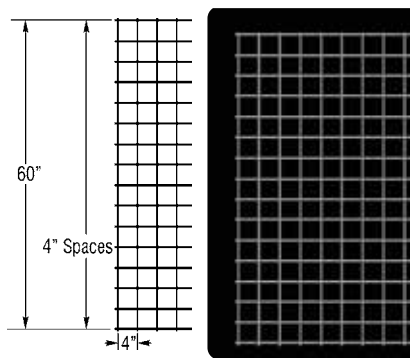

60" Hi-Five 
Item # 33150219

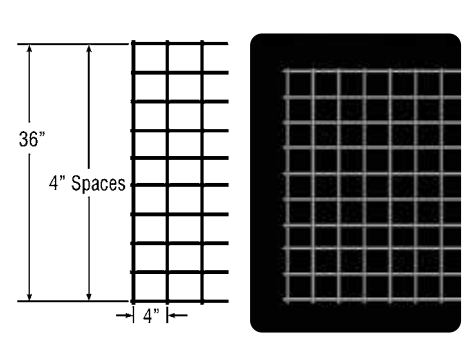

36" Hi-Five 
16' Item # 33150789, 8' Item # 33151029

| DESCRIPTION | HEIGHT (INCHES) | LENGTH (FEET) | BUNDLE QTY | # OF LINE WIRES | WEIGHT (POUNDS) | ITEM # |
|--------------------------|-----------------|---------------|------------|-----------------|-----------------|----------|
| 50" Combo 5 Ga. | 50 | 16 | 50 | 13 | 35 | 33150999 |
| 50" Cattle 5 Ga. | 50 | 16 | 50 | 10 | 29 | 33150739 |
| 34" Hog | 34 | 16 | 50 | 11 | 27 | 33150979 |
| 60" Horse Security 6 Ga. | 60 | 16 | 20 | 16 | 69 | 33150759 |
| 60" Horse Security 6 Ga. | 60 | 8 | 20 | 16 | 34 | 33150659 |
| 60" Hi-Five 5 Ga. | 60 | 16 | 20 | 16 | 55 | 33150219 |
| 36" Hi-Five 5 Ga. | 36 | 16 | 25 | 10 | 36 | 33150789 |
| 36" Hi-Five 5 Ga. | 36 | 8 | 25 | 10 | 18 | 33151029 |

NOTE: Colors pictured may vary from actual product.

Modular Horse Stalls

- **Powder Coated Panels** are finished with full baked gray premium powder coated polyester paint.
- **Premium Hot-Dipped Galvanized Panels** are hot-dipped galvanized after fabrication for the ultimate in corrosion resistance and long life.



Gray Powder Coated Stall Pictured (Wood Customer Supplied)

Stall Features

- Affordable, easy-to-set-up modular system allows for various row configurations.
- Heavy 14 gauge, 2" round tube framing is used for extra strength and stability. Horse Stalls are 84" tall.
- 1/2" solid vertical rods spaced 3" apart allow for better ventilation and viewing.
- Each reversible stall front comes with a 4' left-hand rolling door and 2' feeder door.
- Feeder door swings out easily and is low enough to allow even a child to use.
- Main door rollers on top allow the door to glide easily with minimal effort.
- Optional Corner Feeders can be attached for feeding from outside the stall.
- Lower 4' of stall can be filled with 2" (customer supplied) lumber (Comes with a chart that explains how to cut the wood. Designed to accept any 2" planed lumber ie. 2" x 6", 2" x 8", etc.)
- **For quantities of more than thirty (30) stalls, please call for lead time.**

NOTE: Feed door not to be used as a breezeway opening. Do not leave feed door open when not attended.



Reversible latches allow stall to be easily configured as right or left entrance.



Feed Door Latch



Stall Connectors

NOTE: Stall Connectors do not come with panels - they must be ordered separately.

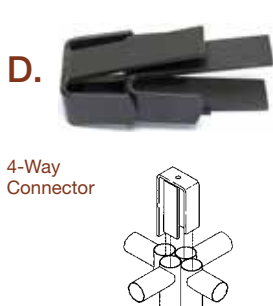
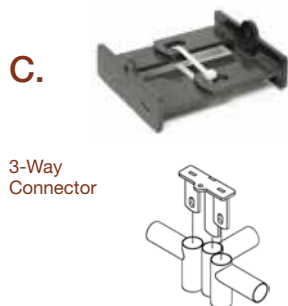
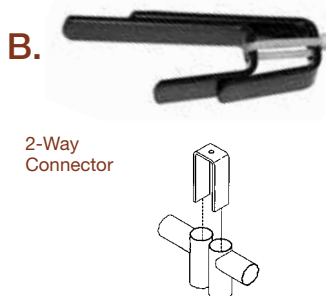
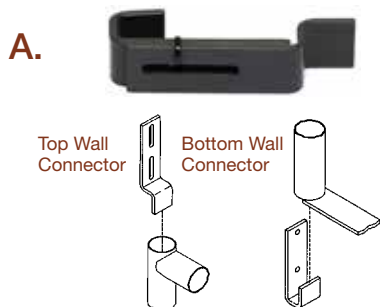

NOTE: UPS Shipping available for stall connectors.

NOTE: Colors pictured may vary from actual product.

| LENGTH & DESCRIPTION | WT (LB) | SHIP UPS* | ITEM # |
|---|---------|-----------|----------|
| GRAY POWDER COATED MODULAR HORSE STALLS | | | |
| 10' Front Panel w/Door, w/Bars | 198 | - | 76110267 |
| 10' Stall Panel w/Bars | 144 | - | 76110277 |
| 10' Solid Panel | 124 | - | 76110247 |
| 12' Front Panel w/Door, w/Bars | 218 | - | 76110287 |
| 12' Stall Panel w/Bars | 169 | - | 76110297 |
| 12' Solid Panel | 144 | - | 76110257 |
| 12' Solid Front Panel w/ Door | 180 | - | 76110727 |
| PREMIUM HOT-DIPPED GALVANIZED HORSE STALLS | | | |
| 10' Front Panel w/Door, w/Bars | 198 | - | 76110269 |
| 10' Stall Panel w/Bars | 143 | - | 76110279 |
| 10' Solid Panel | 122 | - | 76110249 |
| 12' Front Panel w/Door, w/Bars | 218 | - | 76110289 |
| 12' Stall Panel w/Bars | 167 | - | 76110299 |
| 12' Solid Panel | 142 | - | 76110259 |
| 12' Solid Front Panel w/ Door | 180 | - | 76110729 |
| STALL CONNECTORS | | | |
| A. Wall (Pair) | 2 | X | 76110317 |
| B. 2-Way (Pair) | 3 | X | 76110327 |
| C. 3-Way (Pair) | 5 | X | 76110337 |
| D. 4-Way (Pair) | 6 | X | 76110347 |
| E. Gray Butterfly Clamps w/ Nuts & Bolts | 2 | X | 44900067 |
| F. Galvanized Butterfly Clamps w/ Nuts & Bolts | 2 | X | 44900069 |

NOTE: Horse Stalls are 84" tall.

Modular Shelter Kits... Engineered to be Strong and Versatile.

Customized to fit YOUR Operation!

Thirteen prepackaged kits integrate different collections of these great components:

- XT Corral Panels
- Stall Panels
- 12' Open Support Brace
- Shelter Packages
- Roof Connectors

● HOT-DIPPED GALVANIZED ● GRAY

- Can be added to as your needs change.
- Considered a "portable shelter" (can be built in most areas without a building permit, check your local regulations).
- Includes 2" butterfly clamps (gray or galvanized).
- Each stall corner and each connection between corral panels



- requires a pair of connectors; XT Panels come with chain hookups; however, butterfly clamps make a more sturdy connection.
- Corner and center foot pads keep corral panels from sinking.
- Provides a 40-psf roof snow load, 90-mph wind load, when properly installed with 29 gauge or heavier roof sheeting.

IMPORTANT NOTE: The Behlen Country Shelter System will work only with the Behlen Country 12' XT Corral Panels and Behlen Country 12' Stalls. Any substitution with other equipment may not work and will void all warranties. Behlen does not provide roof sheeting, ridge caps, roof screws or wood.

SHIPPING NOTES: Please contact us by phone at (800) 447-2751, for more information.

NOTE: Powder Coated panels are standard. Kits can be itemized to include Hot-Dipped Galvanized panels.



Kit 1 Item # 76078367

One 12' x 12' corral with roof framing package and an open front.

| KIT CONTENTS | ITEM # |
|----------------------------|----------|
| 3) 12' XT Corral Panels | 44131127 |
| 1) 12' Open Support Brace | 76110697 |
| 1) Shelter Framing Package | 76110678 |

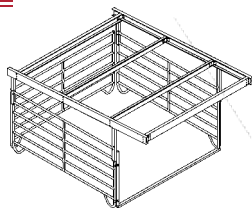

Kit 2 Item # 76078357

One 12' x 12' corral with shelter framing package and an entrance panel front.

| KIT CONTENTS | ITEM # |
|----------------------------|----------|
| 3) 12' XT Corral Panels | 44131127 |
| 1) 12' XT Entrance Panel | 44131037 |
| 1) Shelter Framing Package | 76110678 |
| 1) Horse Gate Latch | 44112207 |

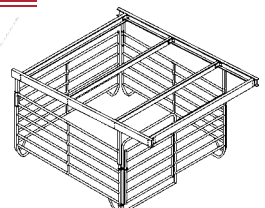

Kit 3 Item # 76078387

One 12' x 12' Behlen Country stall with shelter framing package and open front.

| KIT CONTENTS | ITEM # |
|----------------------------|----------|
| 3) 12' Solid Stall Sides | 76110257 |
| 1) 12' Open Support Brace | 76110697 |
| 1) Shelter Framing Package | 76110678 |

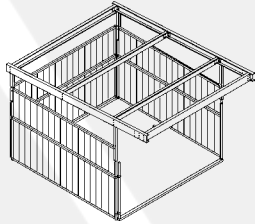

Wood NOT Included

Kit 4 Item # 76078377

One 12' x 12' Behlen Country stall with shelter framing package, solid sides and front with sliding door and feed door.

| KIT CONTENTS | ITEM # |
|-----------------------------------|----------|
| 3) 12' Solid Stall Sides | 76110257 |
| 1) 12' Stall Front w/Door, w/Bars | 76110287 |
| 1) Shelter Framing Package | 76110678 |

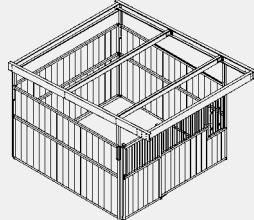

Wood NOT Included

Kit 5 Item # 76078477

Two 12' x 12' corrals side by side, with corral panel divider, open fronts, shelter framing package and add-on shelter package.

| KIT CONTENTS | ITEM # |
|----------------------------|----------|
| 5) 12' XT Corral Panels | 44131127 |
| 2) 12' Open Support Braces | 76110697 |
| 1) Shelter Framing Package | 76110678 |
| 1) Add-on Shelter Package | 76110708 |

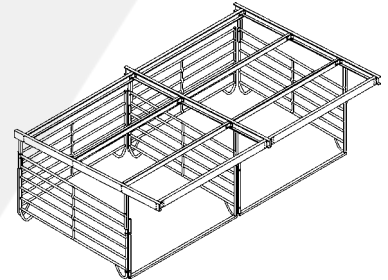

Kit 6 Item # 76078467

Two 12' x 12' Behlen Country stalls, side by side with solid panels, corral panel divider, open fronts, shelter framing package and add-on shelter package.

| KIT CONTENTS | ITEM # |
|----------------------------|----------|
| 4) 12' Solid Stall Panels | 76110257 |
| 1) 12' XT Corral Panel | 44131127 |
| 2) 12' Open Support Braces | 76110697 |
| 1) Shelter Framing Package | 76110678 |
| 1) Add-on Shelter Package | 76110708 |

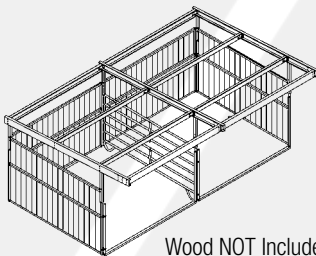

Wood NOT Included

Kit 7 Item # 76078407

Two 12' x 12' corrals with entrance panel fronts, and a 12' wide covered breezeway.

| KIT CONTENTS | ITEM # |
|------------------------------|----------|
| 6) 12' XT Corral Panels | 44131127 |
| 2) 12' XT Entrance Panel | 44131037 |
| 2) Shelter Framing Package | 76110678 |
| 2) 6' Center Roof Connectors | 76110688 |
| 2) Horse Gate Latch | 44112207 |

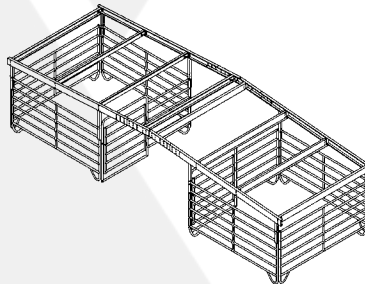

Kit 8 Item # 76078397

Two 12' x 12' Behlen Country stalls with solid sides and fronts with a sliding door and feed door, and a covered 12' wide breezeway.

| KIT CONTENTS | ITEM # |
|------------------------------------|----------|
| 6) 12' Solid Stall Panels | 76110257 |
| 2) 12' Stall Fronts w/Door, w/Bars | 76110287 |
| 2) Shelter Framing Packages | 76110678 |
| 2) 6' Center Roof Connectors | 76110688 |

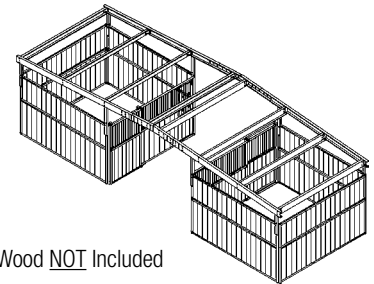

Wood NOT Included

Kit 9 Item # 76078517

Two 12' x 12' corrals with entrance panel fronts and rears, a covered 12' breezeway and 12' x 24' runs.

| KIT CONTENTS | ITEM # |
|---|----------|
| 14) 12' XT Corral Panels | 44131127 |
| 4) 12' XT Entrance Panels | 44131037 |
| 2) Shelter Framing Packages | 76110678 |
| 2) 6' Center Roof Connectors | 76110688 |
| 2) Horse Gate Latches (for fronts only) | 44112207 |

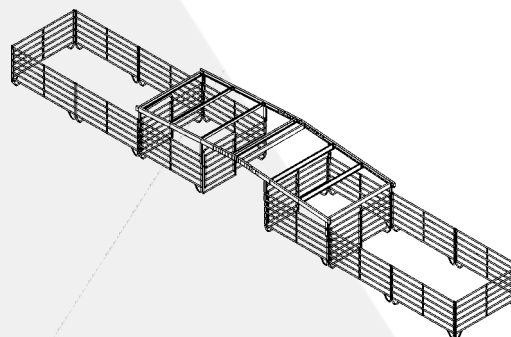



Kit 10 Item # 76078437

Four 12' x 12' corrals with entrance panel fronts and a covered 12' wide breezeway.

| KIT CONTENTS | ITEM # |
|------------------------------|----------|
| 10) 12' XT Corral Panels | 44131127 |
| 4) 12' XT Entrance Panels | 44131037 |
| 2) Shelter Framing Packages | 76110678 |
| 2) Add-on Shelter Framing | 76110708 |
| 3) 6' Center Roof Connectors | 76110688 |
| 4) Horse Gate Latches | 44112207 |

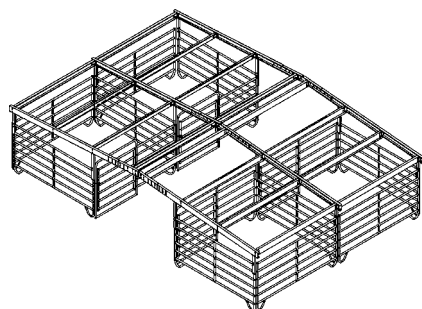

Kit 11 Item # 76078427

Four 12' x 12' Behlen Country stalls with solid sides and fronts with sliding door and feed door, and a covered 12' wide breezeway.

| KIT CONTENTS | ITEM # |
|------------------------------------|----------|
| 10) 12' Solid Stall Panels | 76110257 |
| 4) 12' Stall Fronts w/Door, w/Bars | 76110287 |
| 2) Shelter Framing Packages | 76110678 |
| 2) Add-on Shelter Framing | 76110708 |
| 3) 6' Center Roof Connectors | 76110688 |

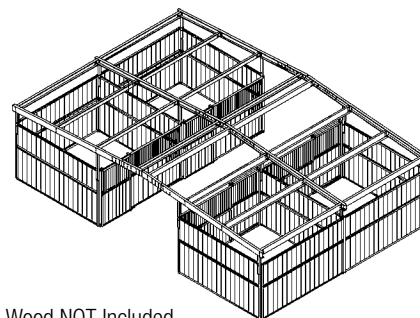

Wood NOT Included

Kit 12 Item # 76078557

Four 12' x 12' corrals with entrance panel fronts and rears, a covered 12' wide breezeway and 12' x 24' runs.

| KIT CONTENT | ITEM # |
|---|----------|
| 22) 12' XT Corral Panels | 44131127 |
| 8) 12' XT Entrance Panels | 44131037 |
| 2) Shelter Framing Packages | 76110678 |
| 2) Add-on Shelter Packages | 76110708 |
| 3) 6' Center Roof Connectors | 76110688 |
| 4) Horse Gate Latches (for fronts only) | 44112207 |

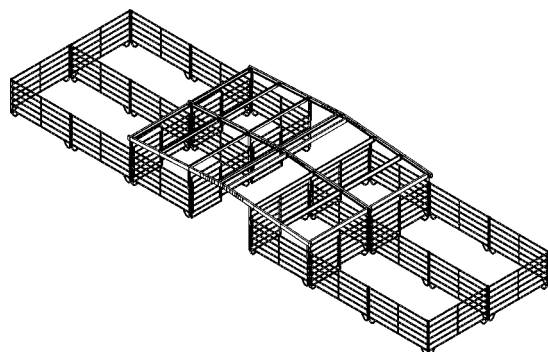

Kit 13 Item # 76078547

Four 12' x 12' Behlen Country stalls with solid sides, fronts with sliding door and feed door, and solid backs with sliding door, with a covered 12' breezeway, and 12' x 24' runs.

| KIT CONTENT | ITEM # |
|------------------------------------|----------|
| 6) 12' Solid Stall Panels | 76110257 |
| 4) 12' Stall Fronts w/Door, w/Bars | 76110287 |
| 4) 12' Solid Front Panel w/Door | 76110727 |
| 16) 12' XT Corral Panels | 44131127 |
| 2) Shelter Framing Packages | 76110678 |
| 2) Add-on Shelter Framing | 76110708 |
| 3) 6' Center Roof Connectors | 76110688 |

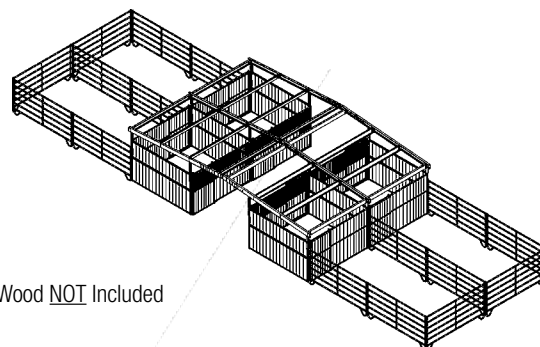

Wood NOT Included

Modular Shelter Components

• NOTE: The Behlen Country shelter system will work only with Behlen Country 12' XT Corral Panels and Behlen Country 12' Stalls Panels. Any substitution with other equipment will not work and all warranties will be voided. Pictures showing installations complete with roof sheeting and wood sides are for reference only. Behlen Country does not provide roof sheeting, ridge caps, roof screws or wood. (Photos shown are variations of kits.) Behlen Country previously made a 12' x 12' shelter. None of these 12' x 15' shelter parts will fit the older units.

• NOTE: In a row of shelters, you would buy one Shelter Framing Package (76110678) and from that point on, you would buy all Add-ons (76110708). If you placed two shelters facing each other with a breezeway between them you would have to buy two Shelter Framing Packages and two 6' Center Roof Connectors (76110708). Each additional pair of facing stalls would require two more add-on framing packages and one more 6' center connector.

• NOTE: 6' Center Connectors are not used unless you are setting up pairs of shelters facing each other with a breezeway between them.

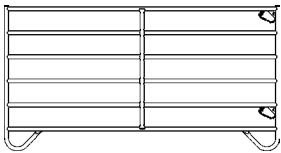

12' XT Corral Panel
Item # 44131127 (Gray)
Item # 44131129 (Galvanized)
 12' long, 6' high, 16/18 gauge 2" dia. tubing, chain hookups included.

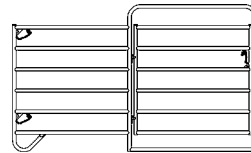

12' XT Entrance Panel
Item # 44131037 (Gray)
Item # 44131039 (Galvanized)
 12' long, 6' high with 6' x 7' gate, used for front (or back, or both) of XT pen.

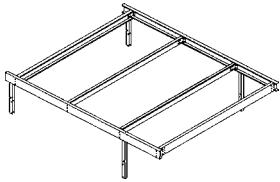

Shelter Framing Package
Item # 76110678
 Basic roof framing for one pen or stall (12' x 15' w/front overhang), includes beams, purlins, shelter posts, butterfly clamps (to connect stall and XT Panels) and hardware.

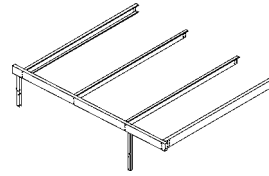

Shelter Framing Package Add-on **Item # 76110708**
 For second unit. Bolts to Shelter Framing Package, uses common beam. Includes beams, purlins, shelter posts, butterfly clamps (to connect stall and XT Panels) and hardware.

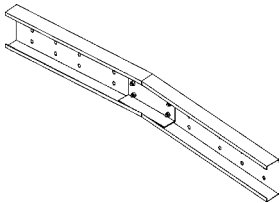

6' Center Connector
Item # 76110688
 This item makes a 6' piece that joins two shelters which are set up facing each other with a 12' breezeway in between. For a pair of shelters, you would buy two 6' Center Connectors. For each additional pair of stalls, you would buy one more center connector.

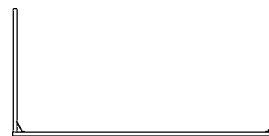

12' Open Support Brace
Item # 76110697 (Gray)
Item # 76110699 (Galvanized)
 If you leave the front or back of a pen or stall open, you must use a 12' Open Support Brace to hold the sides securely. **When ordered as an individual component, 4 pair (2 pkgs.) of butterfly clamps must be ordered separately.**

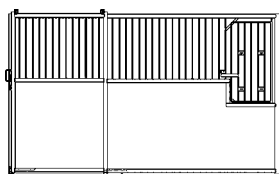

Filler NOT Included

12' Stall Front w/Door, w/Bars
Item # 76110287 (Gray)
Item # 76110289 (Galvanized)
 12' wide, 7' high, 4' wide sliding door, 2' wide feed door, (feeder optional), customer supplied filler on bottom, solid steel vertical bars on top.

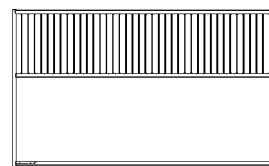

Filler NOT Included

12' Stall Panel w/Bars
Item # 76110297 (Gray)
Item # 76110299 (Galvanized)
 12' wide, 7' high, customer supplied filler on bottom, solid steel vertical bars on top.

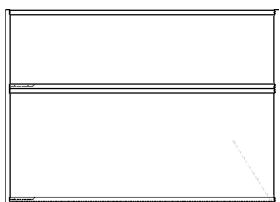

Filler NOT Included

12' Stall Panel, Solid
Item # 76110257 (Gray)
Item # 76110259 (Galvanized)
 12' wide, 7' high, metal frame with customer supplied filler on top and bottom.

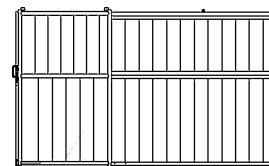

Filler NOT Included

12' Solid Stall Front w/Door
Item # 76110727 (Gray)
Item # 76110729 (Galvanized)
 12' wide, 7' high, 4' wide sliding door, customer supplied filler on top and bottom.

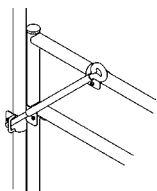

Optional Horse Gate Latch
Item # 44112207
 Very simple, low-cost, bolt-on latch for XT Entrance Panel, or any other 1-5/8" or 2" Behlen gate.



Industry-Leading Equine Feeding & Watering Equipment



Wall Hay Rack

Made with 3/8" dia. rod and finished with our gray premium powder coat paint.

- H/W/D 27"/33"/13" Depth from wall is 13" • WT 15 lb

Item # 76110867 



Corner Hay Rack

Made with 3/8" dia. rod and finished with our gray premium powder coat paint.

- H/W/D 32"/30"/30" Depth from corner is 30" • WT 17 lb

Item # 76110907 



Galvanized Wall Feeder

Holds hay and grain. Constructed of heavy galvanized steel and hay rack is constructed from solid, galvanized rod. Includes a poly trough that is rust and corrosion free.

- H/W/D 31"/24"/19" • WT 37 lb

Item # 76110148 



Galvanized Corner Feeder

Corner design holds hay and grain. Constructed of heavy galvanized steel and hay rack is constructed from solid, galvanized rod.

Includes a poly trough that is rust and corrosion free. Compatible with Behlen Country stall fronts with feed door.

- H/W/D 27"/21"/24" • WT 32 lb

Item # 76110128 



Swing Out Corner Feeder

For applications where a feed door is not already installed. *Not intended for stall fronts with feed door.

- H/W/D 35"/20"/12" • WT 61 lb

Item # 76110138 



Poly Wall Feeder w/Brackets

Poly Wall Feeder features one-piece molded unit with smooth edges and a galvanized hay rack.

- H/W/D 28"/24"/18" Depth from wall 18" • WT 19 lb

Item # 78110147 



UPS shipping is available for all items on this page.



Poly Corner Feeder

Made of poly with solid, galvanized rods for the hay rack. One-piece molded unit with smooth, rounded edges for animal safety. Compatible with Behlen Country stall fronts with feed door.

• H/W/D 35"/21"/21" • WT 22 lb

Item # 78110067



Poly Horse Grain Feeder

Feeder helps prevent throwing, pushing or spilling feed from the bowl. Smooth edges prevent animal injuries. Can be mounted in the corner or on a flat surface.

• H/W/D 11"/24"/15" Depth from wall 10" • WT 4 lb • 3.5 gal. cap.

Item # 78110037



Poly Utility Corner Feeder

Large capacity feeder that will not rust, warp or deteriorate in sunlight. Includes drain for easy cleaning. • H/W/D 28"/24"/24" Depth from corner 30" • WT 19 lb

Item # 78110027



Multipurpose Storage Container

Features all-poly construction that will not corrode or rust and a strong metal hinge to support the lid. Holds up to 400 lb of feed and can be divided into two compartments using 2 pieces of 1" thick lumber (customer supplied). • L/W/H 24"/25"/34" • WT 33 lb • Gray

Item # 78110087



Grooming Step

Made of strong roto-molded poly with a wide base design that is stable and the steps are slip resistant. Ideal extra step up when grooming or mounting a horse.

• H/W/D 24"/24"/17" • WT 17 lb

• Green

Item # 78110162



5-Gallon Stall Waterer

One-piece, heavily insulated waterer, poly design is rust and corrosion free. Urethane in the walls provide over four times the insulation of competitors' models (tested to -20° F*). • H/W/D 16"/18"/16" Depth from wall 12" • WT 14 lb

Item # 54140058S

*Tested 24 hours in a controlled environment.



Patience Pole

The 12' tall Patience Poles are designed with a hub and tether bar to allow the horse to freely move in a circle without becoming tangled. After a while, the horse realizes they aren't going to get anywhere, so they might as well stand and relax. Made with an industrial grade bearing that never requires lubrication the poles are attractive and require virtually no upkeep.

• WT 160 lb • Green

Item # 76178562



UPS shipping is available for all items on this page excluding 78110087, 76178562, 78110162. Please call us at 800-447-2751 or visit www.behlencountry.com for more information.

NOTE: Colors pictured may vary from actual product.

Best Hay Saving Design on the Market!



These bale feeders pay for themselves!

HaySmart™ Bale Feeder

The Haysmart™ Feeder keeps the bale suspended off the ground at an ideal eating height which increases hay utilization to more than 96% compared to 85% with other feeding methods. Finished with our premium powder coat paint. Superior strength and durability, 16 ga. heavy-duty sheeting, 14 ga. tubing, 16 ga. diagonal. Grade 5 plated hardware, ¼" Grade 40 high test chain.

- Feeding Spaces • HT 72" • WT 637 lb

Item # 26120512  GREEN



V Bar Hay Feeder

Designed for feeding large, square bales up to 4' x 8', this rugged feeder is designed with longevity in mind due to the unique V Bar design. Heavy 14 & 16 gauge 2" tubing makes this one of our heaviest feeders.

- Feeding Spaces 16 • HT 56.5"
- WT 518 lb

Item # 26000302  GREEN





Super-Duty

Constructed using 2" 14 gauge for the horizontal tubing and 1-5/8" 16 gauge tubing for the S-bar dividers. Finished with our premium powder coat paint.

- Feeding Spaces 15 • HT 52" • WT 252 lb

Item # 26100181  RED



Hay Ring

Open top design for feeding both horses and horned cattle. Finished with our premium gray powder coat paint.

- HT 34" • WT 155 lb

Item # 26121027  GRAY

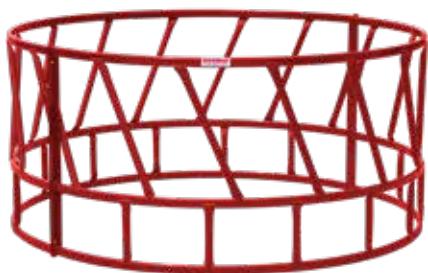

Two Piece Heavy-Duty

Recommended for the toughest situations, constructed with heavy 1-5/8" slant bars and a 14 ga. oval tube frame. Two-piece construction makes for simple assembly.

- Feeding Spaces 15 • HT 46" • WT 171 lb

RED Item # 26100311  RED

GREEN Item # 26100312  GREEN



Now with nibble-notched S-Bars.



Heavy-Duty

A great heavy-duty feeder. 16 ga. S-Bar dividers save more hay. Heavy-duty 2" 16 ga. tube frame. Finished with our green premium powder coat paint.

- Feeding Spaces 15 • HT 52" • WT 224 lb

Item # 26100552  GREEN



Open Top

Open top design creates a horse safe feeder. Frame built with strong 16 ga. tubing. Finished with our gray premium powder coat paint.

- Feeding Spaces 9 • HT 50" • WT 176 lb

Item # 26121157  GRAY



All Poly

Long-life polyethylene pipe design. Comes with a 7 year warranty. Available in quantities of 10.

NOTE: Holes are pre-drilled

- Feeding Spaces 6 • HT 46" • WT 100 lb

Item # 3018500  BLACK



Sheeted Medium-Duty

Our best value sheeted feeder. 16 ga. S-bar dividers save more hay. Strong 16 ga. oval tube frame. Finished with our green premium powder coat paint.

- Feeding Spaces 12 • HT 45" • WT 154 lb

Item # 26100522  GREEN



Economy

The Economy Bale Feeder features a 16 gauge galvanized frame making it a durable feeder at a great price.

- Feeding Spaces 12 • HT 42" • WT 106 lb

Item # 26100138  GALVANIZED



Square Bale Feeder

This easy to use 4' x 8' square bale feeder features pin hook-ups and heavy-duty 2" 16 gauge tubing. Quickly get your animals fed with this great feeder.

- Feeding Spaces 14 • HT 52" • WT 181 lb

Item # 26170012  GREEN

NOTE: Colors pictured may vary from actual product.

Hay Feeder Panels

Great for feeding hay in-line or from a stack, these panels can be connected together or mounted separately. Designed to withstand abuse from the toughest animals. Made from heavy 16 ga. 2" tubing. S-Bar Design saves hay and keeps calves out of the feed.  GREEN

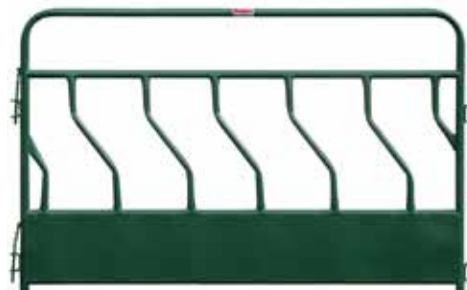

| L (FT) | HT (IN) | WT (LB) | FEEDING SPACES | ITEM # |
|--------|---------|---------|----------------|----------|
| 6 | 66 | 66 | 4 | 26178062 |
| 8 | 66 | 89 | 6 | 26178082 |
| 10 | 66 | 105 | 7 | 26178102 |
| 12 | 66 | 125 | 9 | 26178122 |



Calf Creep Feeders

Calf Creep Feeders are built with one-piece poly feed hoppers which feature molded-in side deflectors to provide protection from rainwater. Tall side height of galvanized grill and trough keep large animals from reaching into feed area and calf pass panel lets only calves in and keeps larger cows out.

| DESCRIPTION | STALL W/L/H (INCHES) | FEEDER L/W (INCHES) | FEED/LB CAPACITY | CALF CAPACITY | WEIGHT (POUNDS) | ITEM # |
|------------------------------------|----------------------|---------------------|------------------|---------------|-----------------|----------|
| Calf Creep Feeder - 750 lb | 52 x 88 x 47 | 54.5 x 34 | 750 | 25 | 303 | 24121768 |
| Calf Creep Feeder - 1200 lb | 54 x 88 x 47 | 87.375 x 34 | 1200 | 40 | 408 | 24121778 |
| Grill Pkg Only (fits both feeders) | - | - | - | - | 130 | 24121518 |
| Hopper Only - 750 lb | - | 54.5 x 34 | 750 | - | 173 | 24121538 |
| Hopper Only - 1200 lb | - | 87.375 x 34 | 1200 | - | 287 | 24121548 |

Calf Pass Panel

The Calf Pass Panel is a versatile way to keep larger animals out of smaller animal feed areas. Chain connectors allow lockup to any post or panel. Provides 8 spaces with a width of 15" per space and maximum height of 46.5"

• L 12' • HT 66" • WT 111 lb

Item # 40168012  GREEN





Hot-Dipped Galvanized base outlasts all others!

Super Wind Vane Feeder 

The hot-dipped galvanized base provides the most corrosive resistant base in the industry against salt, mud, manure, etc. The heavy-duty sealed, plated bearing offers years of maintenance-free service and reliable spinning action. The 2 compartment poly feeder hood will not corrode. Optional face fly attachment.

- L/W/H 48" x 53" x 57" • Green
- Capacity 3 cu. ft. • WT 94 lb

Item # 28120002
 Service Kit **Item # 28120012**
 Face Fly Attachment **Item # 28110080**



Super 3 Block Mineral Feeder

Feeder features a 3 compartment base that is 9" taller than the standard model. The base has 3 anchor points to eliminate tipping.

- W/H 40" x 17" • Capacity 4.6 cu. ft.
- WT 56 lb • Green

Item # 28140212
 Replacement Lid **Item # 3018098**



Wind Vane Feeder 

The Wind Vane Feeder is tough, functional and economical. The all-poly rotating head protects the minerals and the wide base ring makes for a long, functional, and useful life.

- L/W/H 48" x 48" x 58" • Black/Gray
- Capacity 1.9 cu. ft. • WT 59 lb

Item # 28040307



3 Block Mineral Feeder

Tough enough for bulls and easy enough for small animals. The self-closing rubber cover keeps out rain, snow and dirt. Has 3 compartments to hold material.

- W/H 40" x 8" • Capacity 3.5 cu. ft.
- WT 40 lb • Gray

Item # 28140197
 Replacement Lid **Item # 3018098**
 Hardware Pkg **Item # 28300888**



BACK BY POPULAR DEMAND!

Liquid Feeder 

The Liquid Feeder is a great way to give your cattle access to liquid feed. The graduated scale shows liquid feed levels on the translucent poly body. The top lid design elevates the wheels, so water cannot easily enter the tank, protecting your feed investment. The feeder comes with two wheels and can accommodate up to two more! The permanently attached fill cover makes filling the tank a breeze.

- L/W/H 71" x 71" x 36" • Orange/White
- Capacity 285 gallons • WT 110 lb

Item # 28010204



4 Block Mineral Feeder

This 4 compartment feeder is tough enough for bulls and easy enough for small animals. The self-closing rubber cover keeps out rain, snow and dirt.

- W/H 48" x 7" • Capacity 5.0 cu. ft.
- WT 63 lb • Gray

Item # 28140207
 Replacement Lid **Item # 3018097**
 Hardware Pkg **Item # 28300888**

NOTE: Colors pictured may vary from actual product.

Heavy-duty All Metal Feed Bunk

One of the toughest made feed bunks in the industry! This feed bunk is ideal for any size cattle herd. Can be easily moved from pen to pen. Line up multiple units to quickly feed more animals. This unit's heavy-duty construction and high quality, powder coat finish makes it an asset for any size cattle operation.

- Extra Large Capacity • 14 ga. trough
- L/W/H 10' x 40" x 24"
- Trough Depth 14"
- Bunk Capacity 30 cu. ft.
- WT 242 lb

Item # 22130101



Our all metal bunks are heavier, stronger, and hold more than the competition!



REPLACEMENT BUNK LINERS • 5' Item # 2958301

- 10' Item # 2958302
- 11' Item # 2958360



11' Standard Feed Bunk

The Standard Feed Bunk features heavy-duty 16 gauge tubular frame. Tough, one-piece trough insert prevents corrosion. The frame features smooth, all welded edges to prevent injury and square ends that allow multiple bunks to be bolted together.

- L/W/H 11' x 34" x 20" • Trough Depth 10"
- Bunk Capacity 17.5 cu. ft. • WT 113 lb

GREEN Item # 22121942



10' Painted Feed Bunk

Built with heavy-duty steel construction with a one-piece molded poly trough that features smooth, round corners. Square ends allow multiple bunks to be bolted together and are coated with our premium powder coat paint.

- L/W/H 10' x 34" x 19" • Trough Depth 10"
- Bunk Capacity 12.5 cu. ft. • WT 76 lb

Item # 22121791



10' All Metal Utility Bunk

A long-lasting, heavy-duty steel construction with 48% more capacity than some of our biggest competitors' units. The legs of the utility metal feed bunk run the length of the unit to aid in preventing the feeder from sinking in the mud. The all metal utility bunk is made with 16 gauge metal, and is great for all sizes of cattle.

- L/W/H 10' x 33" x 20" • Trough Depth 10" • Bunk Capacity 13.29 cu. ft.
- WT 124 lb

Item # 22120101



Poly Feed Bunks

All poly feed bunks are roto-molded with extra thick, FDA-approved, food-grade polyethylene that is easy to clean and corrosion free. Poly feed bunks feature ribbed, double-wall construction. The deep, rounded feed troughs and drain openings help prevent spoiling of feed and are tested to -20°F. The pluggable drain also allows these bunks to be used as water troughs.

Larger, Stronger, & will outlast the competition's.

5'

- L/W/H 5' x 31" x 20"
- Bunk Capacity 10 cu. ft.
- Bunk Depth 15" • WT 51 lb

Item # 22122207

10'

- L/W/H 10' x 31" x 20"
- Bunk Capacity 20 cu. ft.
- Bunk Depth 15" • WT 112 lb

Item # 22122217

POLY BUNK DRAIN PLUG Item # 1328286



2-Year WARRANTY
Against livestock damage!

NOTE: Colors pictured may vary from actual product.

Check out our selection of Galvanized Feed Bunks and Hay Racks.

Behlen Country **Galvanized Feed Bunks** are built with heavy-duty steel construction and contain a one-piece molded poly trough that features smooth, round corners. Square ends allow multiple bunks to be bolted together and are coated with our premium powder coat paint. Select models accept our Galvanized Hay Rack. **Galvanized Hay Racks** allow the feeding of loose hay and grain at the same time. These racks bolt directly to the frame of the galvanized feed bunks and are made from solid 3/8" rod for extra durability. Hay Racks come complete with all mounting hardware.

REPLACEMENT BUNK LINERS • 5' Item # 2958301 • 10' Item # 2958302 • 11' Item # 2958360



10' Galvanized Feed Bunk

- L/W/H 10' x 34" x 19" • Trough Depth 10"
- Capacity 12.5 cu. ft. • WT 68 lb

Item # 22121798



5' Galvanized Feed Bunk

- L/W/H 5' x 34" x 19" • Trough Depth 10"
- Capacity 6 cu. ft. • WT 36 lb

Item # 22121758



5' Galvanized Sheep Bunk

- L/W/H 5' x 32" x 14" • Trough Depth 10"
- Capacity 6 cu. ft. • WT 36 lb

Item # 22121748



10' Galvanized Horse Bunk

- L/W/H 10' x 42" x 35" • Trough Depth 10"
- Capacity 12.5 cu. ft. • WT 96 lb

Item # 76110098



5' Galvanized Horse Bunk

- L/W/H 5' x 40" x 35" • Trough Depth 10"
- Capacity 6 cu. ft. • WT 50 lb

Item # 76121898



Galvanized Hay Racks

5' Galvanized Hay Rack

- L/W/H 5' x 34" x 36" • Capacity 12 cu. ft.
- WT 48 lb

Item # 76021908

10' Galvanized Hay Rack

- L/W/H 10' x 34" x 36" • Capacity 24 cu. ft.
- WT 80 lb

Item # 22121818



Deluxe Horse Feeder

This feeder works well when feeding horses in pastures or paddocks, designed with a galvanized hay rack over durable double tub poly liners. The heavy-duty galvanized steel construction allows this feeder to hold up to the harshest natural elements. Replacement liners are available.

- L/W/H 5' x 68" x 70"
- Trough Depth 10"
- Trough Capacity 12 cu. ft.
- Rack Capacity 15 cu. ft.
- WT 156 lb

Item # 76130108

Compact Feeder Offers BIG Capacity

NOTE: Colors pictured may vary from actual product.

Big Value for your Small Animal Needs



All Metal Small Animal Feeder

All metal form made to withstand animal wear and tear. Product design and shallow feed pan deters animals from laying and climbing in while preventing feed from dropping to the ground. 4"x4" 5 gauge mesh hay rack

- L/W/H 48" x 28" x 40"
- Trough Depth 2.5"
- Trough Cap. 2 cu. ft. • Rack Cap. 28 cu. ft.
- WT 67 lb

Item # 22120051  RED



5' Sheep & Goat Feeder w/Hay Rack

This bunk/rack system is built with heavy-duty steel construction and features a one-piece molded poly trough. The grid hay rack prevents waste and the rack placement (closer to the bunk) makes it easier for animals to reach.

- L/W/H 60" x 32" x 35.5"
- Trough Depth 10"
- Bunk Cap. 6 cu. ft. • Rack Cap. 12 cu. ft.
- WT 74 lb

Item # 76021878



V Trough Feeder

V Troughs are 14 inches off the ground and include drain holes to prevent spoilage. Available in 4' and 8'

4' • L/ W/H 48" x 32" x 14" • WT 43 lb • Gray
Item # 74023337

8' • L/ W/H 96" x 32" x 14" • WT 64 lb • Gray
Item # 74023327





Sheep & Goat Wind Vane Feeder

The Sheep & Goat Wind Vane Feeder is tough, functional and economical. The all-poly rotating head protects the minerals and the wide base ring makes for a long, functional, and useful life.

- L/W/H 48" x 48" x 50" • Height to trough 14"
- Black/Gray • Capacity 1.9 cu. ft. • WT 52 lb

Item # 74010037



Feed Troughs

Made with heavy 14 gauge steel and Mig welded to assure leak-proof construction. Finished with our premium powder coat paint. Available in 2' and 4'

2' • L/ W/H 24" x 18" x 7" • WT 15 lb • Gray • Item # 56121027

4' • L/ W/H 48" x 18" x 7" • WT 26 lb • Gray • Item # 56121047



Economy Hog Feeders

The Economy Hog Feeders are made from galvanized steel and available in one or two-door configurations. Feeders have a trough feed adjustment control and come fully assembled. Not recommended for confinement installations.

P1 • L/ W/H 12" x 22" x 28" • Capacity 2. cu. ft. • WT 26 lb • Item # 70120058

P2 • L/ W/H 24" x 22" x 28" • Capacity 2.88 cu. ft. • WT 41 lb • Item # 70120048

Small Animal Poly Creep Feeders

Easily get young, small animals on feed with a Behlen Country Small Animal Creep Feeder. Multiple models available to accommodate a wide range of animals. A feed flow panel allows for the adjustment to the flow of feed to the animals. Corrosion resistant with a primarily poly design. Includes a feed saving lid (except on single hole model).

| DESCRIPTION | HOLE SIZE | L/W/H | APPROX. CAP. CU. FT. | WT LB | ITEM # |
|-------------|----------------|----------------------|----------------------|-------|----------|
| 1 HOLE | 6.75" x 3" | 7.5" x 3.75" x 11.5" | .125 | 2 | 70120015 |
| 4 HOLE | 4.375" x 5.25" | 23.5" x 7" x 19.5" | 1.875 | 12 | 70120045 |
| 6 HOLE | 4.5" x 5.25" | 34.5" x 7" x 19.5" | 2.5 | 19 | 70120065 |
| 10 HOLE | 4.5" x 6" | 29" x 8.5" x 20.5 | 3 | 23 | 70120105 |



NOTE: Colors pictured may vary from actual product.

Leading Supplier of Galvanized Stock Tanks

The Behlen Country Galvanized Stock tanks are ideal for all your livestock watering needs. Built to endure the most severe farm and ranch conditions. Corrosion resistant, heavy zinc coating assures long life. Rigid sidewalls have both ribs and corrugations for maximum strength. Heavy galvanized tank bottoms (20 ga.). Heavy, reinforced steel tube rolled into the top lip for added strength and durability.

NOTE: Tank sizes are nominal and will be slightly less than stated size. For lower freight costs, two or three tanks of the same size must be nested, requiring the inner tanks to be undersized.

WARRANTY NOTE: Galvanized Tanks have a ONE-YEAR WARRANTY.



ROUND-END

| NOMINAL SIZE W/H/L FT | NEST SIZE | APPROX. CAP. GAL. | ADJ. TANK BRACES | WT LB | MODEL # | ITEM # |
|---|-----------|-------------------|------------------|-------|---------|----------|
| 2' TALL ROUND-END GALVANIZED TANKS | | | | | | |
| 2 x 2 x 3 | 1 | 71 | - | 36 | RE223 | 50130018 |
| 2 x 2 x 4 | 3 | 103 | - | 43 | RE224 | 50130028 |
| 2 x 2 x 5 | 3 | 134 | - | 52 | RE225 | 50130038 |
| 2 x 2 x 6 | 3 | 169 | - | 64 | RE226 | 50130048 |
| 2 x 2 x 8 | 2 | 224 | 1 | 83 | RE228 | 50130058 |
| 3 x 2 x 8 | 2 | 294 | 1 | 100 | RE328 | 50130088 |
| 1' TALL SHALLOW ROUND-END GALVANIZED TANKS | | | | | | |
| 2 x 1 x 4 | 2 | 44 | - | 30 | ST214 | 50130198 |
| 2 x 1 x 6 | 2 | 70 | - | 44 | ST216 | 50130218 |

NOTE: Tanks must be ordered in nest quantities. Nest Size 1= Size A, Nest Size 2= Sizes A & B, Nest Size 3= A, B & C. Quantities other than 3 may be subject to a surcharge.



2x2x8 Is Back!



ROUND

| NOMINAL SIZE W/H FT | NEST SIZE | APPROX. CAP. GAL. | WT LB | MODEL # | ITEM # |
|---|-----------|-------------------|-------|---------|----------|
| 2' TALL ROUND GALVANIZED TANKS | | | | | |
| 3 x 2 | 2 | 85 | 40 | R32 | 50130118 |
| 4 x 2 | 2 | 165 | 54 | R42 | 50130128 |
| 6 x 2 | 3 | 389 | 114 | R62 | 50130148 |
| 8 x 2 | 3 | 706 | 163 | R82 | 50130168 |
| 10 x 2 | 3 | 1117 | 266 | R102 | 50130188 |
| 1' TALL SHALLOW ROUND GALVANIZED TANKS | | | | | |
| 1 x 4 | 2 | 90 | 43 | SRT41 | 50130248 |
| 1 x 6 | 2 | 192 | 98 | SRT61 | 50130268 |

NOTE: Tanks must be ordered in nest quantities. Nest Size 1= Size A, Nest Size 2= Sizes A & B, Nest Size 3= A, B & C. Quantities other than 3 may be subject to a surcharge.

NOTE: Colors pictured may vary from actual product.



Bottomless Planters

Made from the same steel as our galvanized stock tanks, this heavy-duty galvanized planter will make a great addition to any backyard garden. The 3 foot round makes a great fire pit ring.

| NOMINAL SIZE W/H/L IN FEET | NEST SIZE | WT LB | ITEM # |
|-------------------------------|--------------|----------|----------|
| BOTTOMLESS PLANTERS | | | |
| 3' dia. x 1' tall | 2 | 19 | 50601368 |
| 2 x 1 x 4 | 2 | 20 | 50601358 |
| 2 x 1 x 6 | 2 | 24 | 50601378 |

NOTE: Tanks must be ordered in nest quantities. Nest Size 1= Size A, Nest Size 2= Sizes A & B, Nest Size 3= A, B & C. Quantities other than 3 may be



Galvanized Waterer Tanks

- The poly waterer has a large opening to make it easier for animals to drink.
- The waterer box and float are molded from tough, food-grade polyethylene for cleanliness and long life.
- The built-in float guard protects the valve and float mechanism.
- Valves adjust easily for proper water level.
- The rubber gasket seal prevents leaking.

| NOMINAL SIZE W/H/L IN FEET | APPROX. CAP. GAL. | WT LB | MODEL # | ITEM # |
|---------------------------------|----------------------|----------|----------|-----------|
| GALVANIZED WATERER TANKS | | | | |
| 2 x 2 x 4 | 100 | 58 | RE224RW1 | 501300281 |
| 2 x 2 x 6 | 165 | 79 | RE226W1 | 501300481 |

GALVANIZED WATERER ACCESSORIES

| ACCESSORY | SHIP UPS | WT LB | MODEL # | ITEM # |
|---------------|----------|----------|---------|----------|
| Waterer Kit | X | 18 | WK | 50131018 |
| Valve & Float | X | .5 | W320A | 56010188 |
| Float & Arm | X | .5 | - | 56100528 |

WARRANTY NOTE: Galvanized Tanks have a ONE-YEAR WARRANTY.



NOTE: There is a minimum dollar amount for all UPS shipping orders. Please call us at 800-447-2751 or visit www.behlencountry.com for more information.



Expanded!

Galvanized Stock Tank Selection



| NOMINAL SIZE L/W/H | NEST SIZE | WT LB | APPOX. CAP. GAL. | ITEM # |
|-----------------------------------|--------------|----------|---------------------|----------|
| SQUARE TANKS | | | | |
| 34" x 34" x 12" | 2 | 42 | 60 | 50140078 |
| 34" x 34" x 24" | 2 | 59 | 120 | 50140088 |
| TRIANGLE TANKS | | | | |
| 40" x 34" x 12" | 2 | 38 | 30 | 50140048 |
| 40" x 34" x 24" | 2 | 59 | 60 | 50140058 |
| UTILITY TANKS WITH HANDLES | | | | |
| 18" x 35" x 12" | 2 | 20 | 25 | 50140068 |
| 18" x 35" x 24" | 2 | 28 | 50 | 50140018 |
| 24" x 24" x 12" | NA | 19 | 19 | 50140038 |
| 24" x 24" x 24" | NA | 27 | 38 | 50140028 |

NOTE: Tanks must be ordered in nest quantities. Nest Size 1= Size A, Nest Size 2= Sizes A & B, Nest Size 3= A, B & C. Quantities other than 3 may be subject to a surcharge.

- Prime, heavy duty 20 gauge galvanized steel side and bottoms
- 1" smooth crush-proof rim for longer lasting strength
- Unlimited uses!
- Galvanized tanks have a one-year warranty
- Made in the USA 

New utility tanks feature handles!



Rigid Poly Stock Tanks

- Seamless single piece construction
- Patented stacking blocks
- Reinforced top rim and bottom withstands the rough use of large animals
- Two-year manufacturer's warranty
- Made in the USA 

NEW PRODUCTS



27 Gallon
52120275



75 Gallon
52120755



300 Gallon
52123005



Hog Waterer
52121015

| NOMINAL SIZE L/W/H | WT LB | APPOX. CAP. GAL. | ITEM # |
|-----------------------|----------|---------------------|----------|
| RIGID TANKS | | | |
| 42" x 20" x 12" | 13 | 27 | 52120275 |
| 52" x 31" x 14" | 26 | 60 | 52120605 |
| 44" x 31" x 25" | 30 | 75 | 52120755 |
| 52" x 31" x 25" | 36 | 100 | 52121005 |
| 57" x 42" x 25" | 55 | 150 | 52121505 |
| 82" x 48" x 26" | 84 | 300 | 52123005 |
| HOG WATERER | | | |
| 52" x 31" x 25" | 42 | 100 | 52121015 |

Hog Waterer Replacement Arm & Float Assembly

- .45 Orifice
- WT 3 oz

Item # 3888246S



NOTE: Colors pictured may vary from actual product.

Flex Poly Stock Tanks

- Durable, solid design resists breakage.
- All round-end tanks have an extra heavy-duty, molded rim and an extra-deep sidewall rib design for additional strength.
- Round tanks have a “formed open” rim.
- Heavy-duty, molded-in aluminum drain fitting and 1¼" poly drain plug ensure a long-life. (PRE214 & PRE216 have no drain plugs because they are easy to tip.)
- FDA food-grade approved poly, tested to -20° F, corrosion-free, impact resistant and recyclable.
- Premium UV Protection assures long life and resistance to color fade in outdoor use.



WARRANTY NOTE: Flex Poly Round Tanks have a TWO-YEAR WARRANTY. **Flex Poly Round End Tanks** have a THREE-YEAR WARRANTY.

| NOMINAL SIZE W/H/L | APPROX. CAP. GAL. | COLOR | WT LB | MODEL # | ITEM # | SUGGESTED MINIMUM |
|--------------------|-------------------|-------|--------|----------|----------|-------------------|
| A. 6' x 2' | 350 | Blue | 66 | PR62 | 52113068 | 2 |
| B. 8' x 2' | 625 | Blue | 94 | PR82 | 52113088 | 2 |
| C. 9' x 2'-4" | 1000 | Blue | 119 | PR928 | 52113098 | 2 |
| D. 3' x 2' x 8' | 300 | 77 | PRE328 | 52112187 | 2 | |

NOTE: Minimum nested order quantity of 2 suggested for Round Poly Tanks to ensure stability when shipping.



Deluxe Fun Pool

Deluxe Fun Pool is made with one-piece construction, will not rust, rot or corrode. Wide, heavy-duty rim has no sharp edges. Built-in fun slide, two built-in seats, and four built-in cup holders.

- L/W/H 90" x 80" x 24"
- Approximate Capacity 500 gallons
- WT 90 lb
- Model DFP
- Item # 52113018





WARRANTY NOTE: Flex Poly Round Tanks have a TWO-YEAR WARRANTY. Flex Poly Round End Tanks have a THREE-YEAR WARRANTY.



| NOMINAL SIZE W/H/L | APPROX. CAP. GAL. | COLOR | WT LB | MODEL # | ITEM # | SUGGESTED MINIMUM |
|--------------------|-------------------|-------------|-------|---------|------------|-------------------|
| E. 2' x 1' x 4' | 50 | Granite Tan | 18 | PRE214 | 52110047GT | 2 |
| F. 2' x 1' x 6' | 70 | Granite Tan | 29 | PRE216 | 52110067GT | 2 |
| G. 2' x 2' x 3' | 65 | Granite Tan | 22 | PRE223 | 52112037GT | 2 |
| H. 2' x 2' x 4' | 100 | Granite Tan | 30 | PRE224 | 52112017GT | 3 |
| I. 2' x 2' x 5' | 125 | Granite Tan | 44 | PRE225 | 52112057GT | 3 |
| J. 2' x 2' x 6' | 150 | Granite Tan | 53 | PRE226 | 52112027GT | 3 |

NOTE: Minimum nested order quantity of 2 suggested for Round End Poly Tanks to ensure stability when shipping.

Free-Flo Valve

Includes an automatic, non-siphon valve to adjust the water level with the turn of a knob. Three gallons per minute works with all tank models.

- WT 4 lb
- Item # 52120148



Poly Round Tub

Perfect alternative to 5 gallon bucket for watering or feeding. UV protection for long life and fade resistance.

- W/H 26" x 9"
- Approximate capacity 14 gallons
- WT 9 lb
- Model PR269
- Item # 28107908



Water Boy w/ GTV Valve

Quickly and easily converts an ordinary garden hose into an automatic animal waterer. Includes an automatic, non-siphon valve (GTV). Adjust the water level by the turn of a knob.

- W/H 30" x 15"
- Approximate capacity 30 gallons
- WT 18 lb
- Model PR3016
- Item # 52114138



NOTE: The 3 items in this section can be shipped via UPS. Please call us at 800-447-2751 or visit www.behlencountry.com for more information.

NOTE: Colors pictured may vary from actual product.

Best Value in the Industry!

Energy-Free Waterers

Energy-Free Waterers

- Built-in hold downs.
- New, non-siphoning MC water valve, which features:
 - Fast, consistent fill.
 - Units have a non-siphoning, easy maintenance water valve.
 - Use with pressure lines from 25-55 p.s.i.
 - Additional pressure regulator required for pressures above 55 p.s.i.
- Removable drain plugs and accessible covers.
- Fully assembled, ready to install.
- To ensure proper operation in cold weather, it is recommended that each unit be installed with the Poly Earth Tube (purchased separately).
- For optimal performance install in shaded area in hot climates.
- Premium UV Protection assures long life and resistance to color fade in outdoor use.



Super 2 or 4-Hole Waterer

Designed for heavy cattle use in extremely cold temperatures. Tested at -20°F for 48 hours without freezing with no animals drinking. Rim design helps keep float balls free of ice buildup. Extra-thick 4" urethane insulation.



Earth Tubes 18" & 24"

Heavily insulated design. Provides the protection needed to keep the riser pipe from freezing below the ground even in the coldest weather.



Shut-off Valve Kit

Hydrant style drain back feature protects waterer from freezing when not in use.



2 or 4-Hole Cattle Waterer

Built-in hold downs. New, non-siphoning MC water valve for up to 55 PSI. Fully assembled and ready to install. Poly Earth Tubes (purchased separately) recommended for operation in freezing weather.

| DESCRIPTION | L/W/H | MIN. ANIMAL CAP. | ANIMAL CAP. GAL. | WATER CAP. GAL. | WT LB | SHIP UPS | MODEL # | ITEM # |
|---------------------------|-----------------|------------------|--------------------|-----------------|-------|----------|---------|-----------|
| SUPER WATERERS | | | | | | | | |
| Super 2-Hole | 44" x 27" x 28" | 20 | 160 Beef/70 Dairy | 40 | 133 | - | SF-2C | 54110068S |
| Super 4-Hole | 44" x 44" x 28" | 30 | 260 Beef/100 Dairy | 80 | 187 | - | SF-4C | 54110078 |
| CATTLE WATERERS | | | | | | | | |
| 2-Hole | 36" x 21" x 23" | 20 | 160 Beef/70 Dairy | 20 | 83 | X | EF-2C | 54110028 |
| 4-Hole | 36" x 36" x 23" | 30 | 260 Beef/100 Dairy | 35 | 127 | - | EF-4C | 54110048 |
| OPTIONAL EQUIPMENT | | | | | | | | |
| Earth Tube | 18" L x 12" W | - | - | - | 8 | X | ET-18 | 54130038 |
| Earth Tube | 24" L x 12" W | - | - | - | 11 | X | ET-24 | 54130048 |
| Shut-off Valve | 12" L | - | - | - | 2 | X | EFSK | 54130168 |

WARRANTY NOTE: Energy-Free Waterers have a FIVE-YEAR LIMITED WARRANTY on the body and a ONE-YEAR LIMITED WARRANTY on valves and controls.

Electric Waterers

- One-piece, heavily insulated waterer, poly design is rust and corrosion free.
- Thick styrofoam floor keeps the frost line below the waterer.
- Low-wattage, infrared heat pad directly under the water trough (starts at approximately 42°F and shuts off at approximately 73°F).
- Heat pads are totally isolated from the animal to prevent danger from shock.
- Double-insulated design eliminates the possibility of stray voltage.

- Units have a non-siphoning, easy maintenance water valve.
- Additional pressure regulator required for pressures above 55 p.s.i.
- An optional low-pressure valve is available for special applications.
- Built-in hold downs.
- Removable drain plugs.
- Easy access doors.
- Fully assembled, ready to install.

- Premium UV Protection assures long life and resistance to color fade in outdoor use.

WARRANTY NOTE: Electric Drinkers have a **FIVE-YEAR LIMITED WARRANTY** on the body and a **ONE-YEAR LIMITED WARRANTY** on valves and controls.



Calf/Sheep/Horse

- L/W/H 28"x 18"x 22"
- HT of trough 16"
- Animal capacity 60
- Watts 100 •Amps 1
- WT 40 lb
- Model AHW60 
- **Item # 54150028**
(Replacement heat pad Item # 2198160S)

Cattle Extra Capacity

- L/W/H 34"x 29"x 30"
- HT of trough 24"
- Animal capacity 250
- Watts 250 •Amps 2.3
- WT 75 lb
- Model AHW250
- **Item # 54150068**
(Replacement heat pad Item # 2198162S)



NEW & IMPROVED DESIGN!

Cattle/Horse

- L/W/H 30"x 26"x 32"
- HT of trough 24"
- Animal capacity 80
- Watts 100 •Amps 1
- WT 64 lb
- Model AHW80
- **Item # 54150018**
(Replacement heat pad Item # 2198160S)



*Oversize UPS charges apply

Horse/Companion

- L/W/H 21"x 22"x 23"
- HT of trough 16"
- Animal capacity Variable
- Watts 75 •Amps .7
- WT 39 lb
- Model AHW30 
- **Item # 54150088**
(Replacement heat pad Item # 2198172S)



Automatic Stall

- L/W/H 12"x 14"x 41"
- HT of trough Adjustable
- Animal capacity 1 Stall
- Watts 100 •Amps 1
- WT 13 lb
- Model ASWH 
- **Item # 54140358S**
(Replacement heat pad Item # 2198160S)

Automatic Stall Unheated

- L/W/H 12"x 14"x 41"
- HT of trough Adjustable
- Animal capacity 1 Stall
- WT 11 lb
- Model ASW 
- **Item # 54140348S**

NOTE: ASWH & ASW Models are NOT Insulated



Maximum Performance for Extreme Weather!

Extreme Weather

Extra thick urethane in the walls provides over four times the insulation of competitors' models. The powerful 220 watt heat pad heats the basin and supply line.

- L/W/H 30"x 20"x 32"
- HT of trough 24"
- Animal capacity 100
- Watts 220 •Amps 2.1
- WT 84 lb
- Model AHW100
- **Item # 54150158**
(Replacement heat pad Item # 2198175S)



NOTE: Colors pictured may vary from actual product.

Stock Tank & Waterer Accessories



Top Mount Float Valve

Can be used with either steel or poly tanks. •WT 3 lb

Item # 3888133



1-1/4" Bulkhead Fitting & Plug

Complete replacement kit for flex poly tanks with damaged 1" flange and plugs, or for adding more drains. •WT 1 lb

Item # 52114108



25' Roll Gasket Kit

•WT 2.5 lb

Item # 56100658



Valve Foam Insulator

For Behlen Country Energy Free Waterers.

•WT Less than 1 lb

Item # 2308019



Drain Plug Package for Flex Poly Tanks

Replacement drain plug package for all our poly tanks. •WT .11 lb

Item # 52300028S



Drain Plug for Galvanized & Rigid Poly Tanks

Plug for drain on all our galvanized stock tanks. •WT .1 lb

Item # 2928077



Bulkhead Kit Galvanized Stock Tanks

3/4" Bulkhead fitting and plug for our galvanized stock tanks. •WT 1 lb

Item # 50130405



Galvanized Tank Sealant

Sealant to seal seam of the Behlen Country galvanized stock tanks. •WT 1 lb

Item # 3288026



MC Valve & Float Assembly for all Electric & Insulated Waterers

•WT 1 lb
Item # 3888244S



MC Valve (no float)

•WT .5 lb

Item # 3888245S



MC Float Assembly (no valve)

•WT .5 lb

Item # 3888251S



MC Plunger & Seal Kit

For MC Valve. •WT Less than 1 lb

Item # 3888266



Low-Pressure Valve

•WT Less than 1 lb

Item # 54130328



Thermostat

For all heated waterers. •WT .1 lb

Item # 3668011



250 Watt Submersible Heater

•WT 3 lb

Item # 52120088



NEW PRODUCT

Tank Stand

•L 45.15" x W 30.25" x H 37.5"

•WT 25 lb *UPS shipping not available

Item # 48102045



NOTE: All of the Tanks & Waterer Accessories listed on these two pages can be shipped via UPS. Unless noted otherwise. Please call us at 800-447-2751 or visit www.behlencountry.com for more information.

Stock Tank & Waterer Accessories



Low-Pressure Valve & Float

•WT Less than 1 lb

Item # 54130338



10" Float Ball

•WT 2.4 lb

Item # 54300082



Rubber Seal for MC Valve

Package of 5. •WT .5 lb

Item # 54300988



Kerrick Valve

For use in ASW-H. •WT .5 lb

Item # 2958378S



Heat Pads •WT 3 lb

75 Watt 10" x 14" **Item # 2198172S**

100 Watt 10" x 19" **Item # 2198160S**

250 Watt 20" x 25" **Item # 2198162S**

220 Watt 20" x 22" **Item # 2198175S**



Drain Plug

For all our insulated and electric waterers, except the AWS.

•WT .5 lb **Item # 54300018**

AHW Waterer Display Stand

The perfect way to display Behlen Country Electric Waterers, shelves are adjustable to accommodate different models.

•W/L/H 36" x 30" x 84"

•WT 100 lb *UPS shipping not available

Item # 80100225



Drinker Internal Parts Replacement Kit

(1) 3' Pressure Hose (3/4" inside dia.), (1) Hose Clamp, (1) 3/4" Elbow, (1) Valve Clamp, (2) 1/4" x 2" Screws, (1) 3/4" Barb Connector

•WT 1.5 lb **Item # 56010008**



Drain Plug Wrench for Galvanized Stock Tanks

Drain plug wrench removes galvanized 3/8" square drain plugs with ease. Made from Grade 1018 Zinc Low Carbon Steel. Slanted for easy use. Dual End Wrench Made in USA.

•WT 1 lb **Item # 50300060**



Durapatch UV™ Kits

Durapatch UV™ is a very unique, easy-to-use UV or sunlight activated, self-adhesive repair patch. It is reinforced Polyester with extremely good adhesion properties for long-lasting repairs. The patch is non-flammable, non-toxic, and the adhesive is not harmful to the skin. Easy to apply, no mixing, no weighing – one step, no mess. FDA approved safe.

- Easy Application
- Fast Cure (15-30 mins)
- Molds to any application
- Impact Resistant
- Can be drilled, sanded or painted
- Cures rock hard
- Rot-proof & Waterproof



UV Flashlight can be used to speed curing time of the Durapatch UV™ Kits.

| DESCRIPTION | UNITS PER CASE | CASE WT LB | ITEM # |
|-------------------------------|----------------|------------|---------|
| Case Durapatch 2" x 3" | 48 | 5 | 2958410 |
| Case Durapatch 3" x 6" | 12 | 16 | 2958412 |
| Case Durapatch 6" x 9" | 12 | 40 | 2958414 |
| Case Durapatch 9" x 12" | 6 | 40 | 2958416 |
| Case UV Flashlight 2.25" x 6" | 50 | 32 | 2958418 |



NOTE: All of the Tanks & Waterer Accessories listed on these two pages can be shipped via UPS. Please call us at 800-447-2751 or visit www.behlencountry.com for more information.

Best Value Chute and Headgate Combos!



Don't Operate Without a Chute

If you keep a herd of 50 head or less, you might not think a squeeze chute is for you. Yes, you can work cattle with a headgate, or the help of a few loyal friends who rope. But there are lots of reasons why use of a squeeze chute should be on the top of your list. Your safety is at the top of that list. Herd health, and the related economic benefit it creates, is also an important payoff.

For example, researchers at the University of Kentucky developed enterprise budgets for 50-cow herds with a \$5,000 investment in handling facilities that included a headgate and chute. The resulting increases in calving percentages and weaning weights, as well as lower death loss rates for both cows and calves, proved that the investment paid for itself in less than five years.

Choosing the Right Chute

Before buying a squeeze chute, you need to answer a few questions about its intended use. Bovines come in all sizes, weights and attitudes, so a chute that works for one producer may not work for another.

Some squeeze chutes apply squeeze pressure from only one side, while others squeeze from both sides, forming a 'V' shape that helps balance and support the animal. Regardless of design, experts agree that the best squeeze chutes allow both sides to squeeze equally, thus keeping

the animal balanced. The Canada Plan Service gives the following guidelines for the inside widths of the chute at the bottom of the V shape:

- Six inches for 250 to 400 pound calves.
- Eight inches for 600 to 800 pound animals.
- Twelve inches for cows and heavy feeders.
- Fourteen to sixteen inches for larger bulls.

Animal scientists with the Alabama Cooperative Extension service list four basic types of headgates: self-catching, scissors-stanchion, positive-control, and full-opening stanchion. Once again, you need to know what kind of animal you'll run through the chute. For example, self-catching gates don't work well with horned cattle. There are lots of options available:

- A door or space that allows injections to be given in an animal's neck is a necessity in order to avoid damaging expensive cuts of meat.
- A service door or palpation cage provides access to the rear of animals.
- Hydraulic squeeze chutes take a lot of the effort out of operation.

Silencer™

Hydraulic Squeeze Chute

- The most innovative and technologically advanced chute in the cattle industry.
- A patented noise reduction system of 130 contact points sheathed in oil based polyethylene to significantly reduce the noise level.
- Full-opening head and tail door.
- The headgate is wrapped in rubber to prevent shoulder damage to the animal.
- Hydraulic head restraint (becomes half of the neck bars when used that way).
- Rubber louvers prevent animals from seeing humans to the side of chute .
- Side exit available Left/Right/Both.
- Neck bar Left/Right.
- Hydraulic Lower Squeeze.
- Dual additional neck access for precision vaccinating.
- Choice of power units.
- For animals from 350 lb on up.
- Gray premium powder coat paint.



Heavy-Duty Model

In addition to the standard features, the main frame has 4" x 2" x 3/16" rectangular tubing, 1/4" wall side-gates, 1/4" floor for increased life of chute, modular construction for superior maintenance, replaceable heavy-duty drop bars, 10 quick change relube roller bearings - top connector and lower head door connector and 6 - 4 x 2 cylinders.

Deluxe Ranch & Heavy-duty Extended Chutes

Silencer Extended model chutes are designed with a rear door for the operator to step in behind the animal for artificial insemination, semen checking, pregnancy checking, embryo transfer, etc.

**Other models and options, are available.
Call 800-447-2751 for quotes.**

Additional Options

Heavy-duty and Commercial Pro, Extended Length, Palpation doors, Pivot Controls, Pivot Controls w/Overhead Scales, Dual Controls, Neck Bars, Hydraulic Neck Extenders Left/Right/Middle, Dehorner Bar, Hydraulic Kick Bar, Yearling Side Gates-Both Sides, Brisket Bar, Rebar Floor, Platform Scales, Vertical/Horizontal Split Drop Pan, Leg Puller.

Chute Specifications

| EQUIPMENT DETAIL | RANCH | Heavy-duty | EXTENDED |
|------------------------|-------|------------|----------|
| Height | 93" | 93" | 93" |
| Head & Tailgate Height | 67.5" | 67.5" | 67.5" |
| Inside Height | 67.5" | 67.5" | 67.5" |
| Outside Length | 100" | 100" | 130.5" |
| Inside Length | 91" | 91" | 120.5" |
| Width (Door Open) | 67" | 67" | 67" |
| Width (Door Closed) | 59" | 59" | 59" |

Hydraulic Chutes & Accessories

| DESCRIPTION | LB* | ITEM # |
|--|------|--------|
| Deluxe Ranch Chute w/ Left-Hand Controls | 2150 | Call |
| Heavy-Duty Chute w/ Left-Hand Control | 2600 | Call |

*Weights will vary per chute with options selected. Weight of chute with 5 H.P. Unit.



M1-V Squeeze Chute

- A user-friendly, heavy-duty chute designed for animal and operator safety.
- Best value in its class.
- Capable of handling the largest mature animals yet providing maximum adjust ability from 2500 lb down to 300 lb cattle.

Standard Features

- Right-hand or left-hand control operation.
- Dual side exits.
- Fully sheeted split tailgate.
- Dual neck access area for safe and easy vaccinations.
- Double-side squeeze.
- Dual side drop-down side bars.
- Drop-down and detachable sheeted side panels.
- Double bottom floor adjusts from 8" - 29" (16 settings).
- HD850 scale brackets on every chute.

Optional Features

- Choice of 3 headgates.
- M-Series chute trailer.
- Palpation A.I. Cage.
- Compatible with any scale system.



Split Tailgate



M-Series Self-Catch Headgate

Easy Access to Neck

M1-V Chute Specifications

Overall Height 99"

Inside Height 69"

Inside Chute Length 96"

Overall Length w/either Headgate or

Split Tailgate 104"

Usable Inside Floor Width 23"

M1-V Chute & Accessories

| DESCRIPTION | LB | ITEM # |
|---|------|----------|
| M1-V Chute w/Fully Sheeted Split Tailgate Mounted *Headgate not included | 1277 | 62175892 |
| M-Series Chute Trailer (w/ rims, no tires) | 430 | 62173692 |

Compatible Headgates

| DESCRIPTION | LB | ITEM # |
|------------------------------|-----|----------|
| M-Series Self-Catch Headgate | 266 | 60110132 |
| M-Series Manual Headgate | 208 | 60110012 |

MX-V

Squeeze Chute

Design Enhancements Provide Safer Functionality for Operator and Animal

- Foot-operated side adjustments is safer for handler and frees up hands!
- Improved side release makes it safer and quicker to release animals.
- New pulley system for vertical tailgate makes it easier to lift.
- Dual purpose tailgate brackets make it easier to attach accessories like A.I. Cage or corral panels.
- Superior value yet economically priced.
- Breakthrough design is tough enough and big enough to handle a wide variety of animals.
- Designed with the safety of the operator and the animal in mind.

Standard Features

- Left-hand control operation.
- Single side exit.
- "Easy Action" vertical lift tailgate.
- Double-side squeeze.
- Double-side drop-down side bars.
- Drop-down sheeted side panels.
- Double-side bottom floor adjusts from 7" - 17" (9 settings) to accommodate a wide variety of animals.
- 1200 lb capacity.
- Includes CL-5 Self-Catch Headgate.

Optional Features

- M-Series Chute Trailer.
- Palpation A.I. Cage.



MX-V Chute Specifications

Height 76.875" Length 97.625" Width 39"



Foot-Operated Adjustments

Improved Side Release

New Pulley System

Chute & Accessories

| DESCRIPTION | LB | ITEM # |
|--|-----|----------|
| MX-V Chute, Incl. Vertical Lift Tailgate & Headgate | 924 | 62175862 |
| Chute to Crowd Alley Adapter (Replaces 1 ea. 64160422 or 64160612 arches when hooking sheeted or unsheeted systems directly to the chute) | 52 | 64402207 |

M-Series Chute Trailer

The M-Series Chute Trailer is a convenient one-man loading and transporting of the M1-V and MX-V Chutes. Chute can be raised and lowered with built-in winch and helps with easy positioning of chute to alleyway. Equipped with 2" ball coupler, adjustable jack, and rims. Does NOT include tires.

*Rims are 15" x 15", 5-Hole

| DESCRIPTION | LB | ITEM # |
|--|-----|----------|
| M-Series Chute Trailer (w/ rims, no tires) | 430 | 62173692 |



Tires Not Included

NOTE: Colors pictured may vary from actual product.

Heavy-Duty Headgates

M-Series Self-Catch Headgate

M-Series Self-Catch Headgate is adjustable from both sides for a more precise fit and increased safety. Adjusts to handle livestock from 300 lb and up and has pins to allow for quick adjustment of width of opening. Attaches to any Behlen Country chute, right or left-hand operation. Recommended for M1-V Behlen Country chutes.



- WT 266 lb
- Item # 60110132

M-Series Manual Headgate

M-Series Manual Headgate features “Pos-o-lock” ratchet system, ensuring that cattle are caught safely and can’t escape. The opening handle attaches parallel to the chute, out of the operator’s way, offering plenty of leverage to reduce operator fatigue.



- M-Series Manual Headgate
- WT 208 lb
 - Item # 60110012

Standard-Duty Headgate

CL-5 Utility Headgate

CL-5 Utility Headgate is perfect for small herds. Can operate via self-catch or manual operation. Mounts to alleyway or any Behlen Country Chute.

DESIGN ENHANCEMENTS!

- Includes an improved bolt on CL-5 Headgate.
- New head knocker guard aids in safety of animal and handler.
- Assist return spring for easier closing.
- Improved release handle for better ergonomics.
- WT 220 lb
- Item # 60110202



Calf Table & A.I. Cage

Calf Table with Headgate

The Calf Table has an updated design for years of use. Locking tilt and reversible headgate make for flexible operation. The Calf Table is a must for branding, castrating and vaccinating calves up to 450 lb.



Calf Table w/Headgate

- L 65" x W 46" x H 62"
- WT 380 lb
- Item # 62176802

Calf Table Headgate Only

- WT 93
- Item # 62176812



A.I. Cage

The A.I. Cage provides a safe, convenient access area behind the chute. Sheeted double doors self lock to block the alley and keep you safe. Attaches to any Behlen Country squeeze chute and allows quick access to the opposite working area.



A.I. Cage

- L 32.5" x W 32.5" x H 80"
- WT 209 lb
- Item #62178422

A.I. Cage Accessory

- A.I. Cage Transport Bracket
- WT 17 lb
 - Item # 62175822

Unsheeted System Kits and Components

Unsheeted System Kit 1

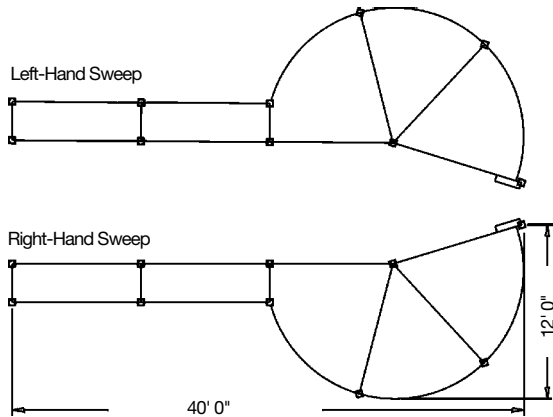

180-degree Sweep with 10' Straight lead-in Panel with 20' of Adjustable Straight Crowd Alley. Includes Drop Down No Back.

- **Item # 46079642 (Model # USK1)**
Will make either of the two systems drawn.

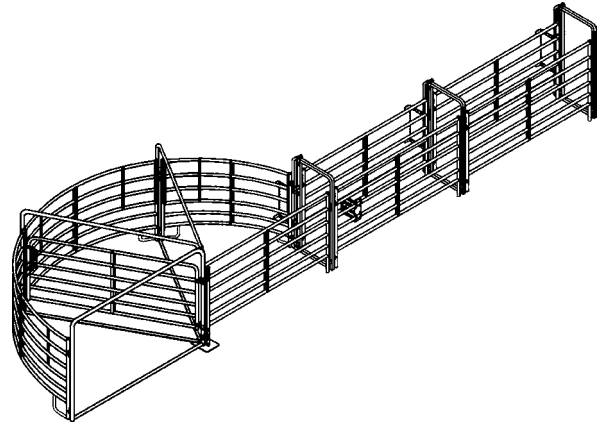

Components

| DESCRIPTION | QTY. | ITEM # |
|---------------------------------------|------|----------|
| 10' Gate Arch Only | 1 | 46180222 |
| 10' Sweep Pen Gate | 1 | 46160292 |
| Sweep Pen Overhead Brace | 1 | 46160312 |
| 10' Curved Sweep Pen Panel | 3 | 46179572 |
| Flat Ground Brace | 2 | 46180212 |
| Latch & Hardware | 1 | 46180272 |
| 10' Straight Crowd Alley Panel | 5 | 46160282 |
| Unsheeted Adj. Alley Arch with Fender | 1 | 64160622 |
| Drop Down No Back | 1 | 64160092 |
| Unsheeted Adj. Alley Arch | 2 | 64160612 |

Unsheeted System Kit 2

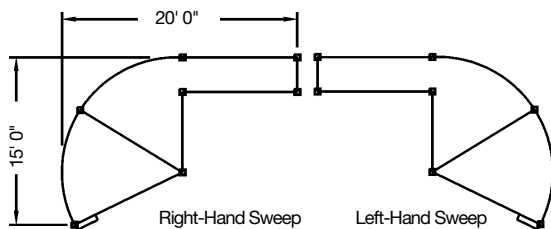

120-degree Sweep with 10' Straight Crowd Alley.

- **Item # 46080002 (Model # USK2)**
Will make either of the two systems drawn.

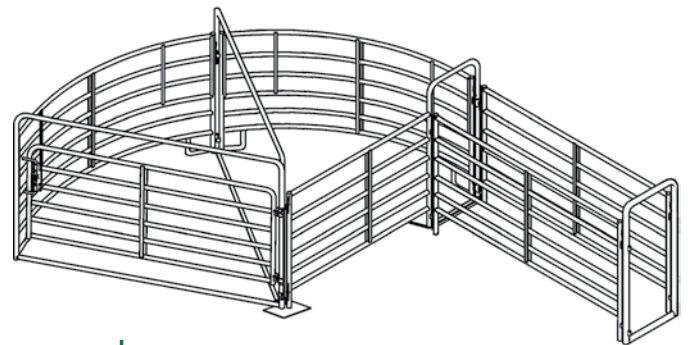

Components

| DESCRIPTION | QTY. | ITEM # |
|--------------------------------|------|----------|
| 10' Gate Arch Only | 1 | 46180222 |
| 10' Sweep Pen Gate | 1 | 46160292 |
| Sweep Pen Overhead Brace | 1 | 46160312 |
| 10' Curved Sweep Pen Panel | 2 | 46179572 |
| Flat Ground Brace | 1 | 46180212 |
| Latch & Hardware | 1 | 46180272 |
| Drop Down No Back | 1 | 64160092 |
| 10' Panel with Alley Arch | 1 | 46180232 |
| 10' Straight Crowd Alley Panel | 2 | 46160282 |
| Non-adjustable Alley Arch | 1 | 46112232 |

NOTE: Colors pictured may vary from actual product.

Unsheeted System Kit 3

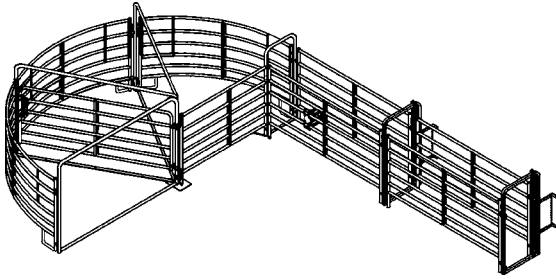

180-degree Sweep with 20' Straight Adjustable Crowd Alley.
Includes Overhead Sweep Pen Brace and Drop Down No Back.

- **Item # 46079662 (Model # USK3)**

Will make either of the two systems drawn.

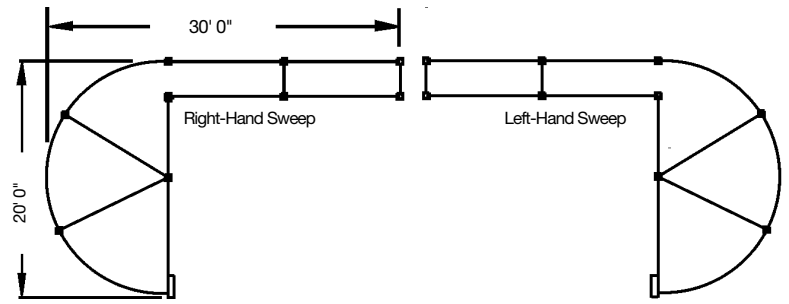

Components

| DESCRIPTION | QTY. | ITEM # |
|--------------------------------|------|----------|
| 10' Gate Arch Only | 1 | 46180222 |
| 10' Sweep Pen Gate | 1 | 46160292 |
| Sweep Pen Overhead Brace | 2 | 46160312 |
| 10' Curved Sweep Pen Panel | 3 | 46179572 |
| Flat Ground Brace | 2 | 46180212 |
| Latch & Hardware | 1 | 46180272 |
| 10' Straight Crowd Alley Panel | 4 | 46160282 |
| Drop Down No Back | 1 | 64160092 |
| 10' Panel with Alley Arch | 1 | 46180232 |
| Unsheeted Adj. Alley Arch | 2 | 64160612 |

Unsheeted System Kit 4

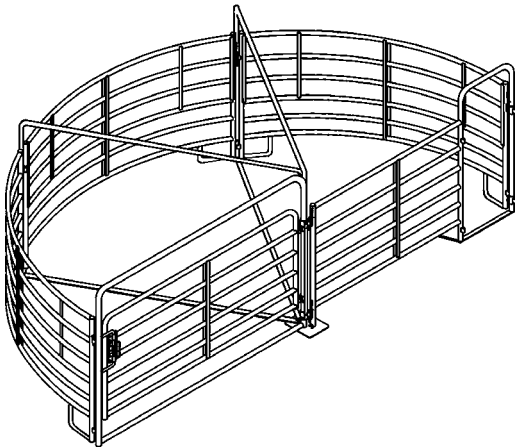

180-degree 3-Panel Sweep Pen.

- **Item # 46079532 (Model # USK4)**

Will make either of the two systems drawn.

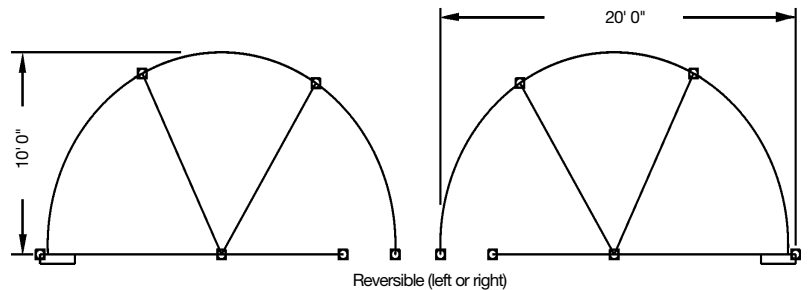

Components

| DESCRIPTION | QTY. | ITEM # |
|----------------------------|------|----------|
| 10' Gate Arch Only | 1 | 46180222 |
| 10' Sweep Pen Gate | 1 | 46160292 |
| Sweep Pen Overhead Brace | 2 | 46160312 |
| 10' Curved Sweep Pen Panel | 3 | 46179572 |
| Flat Ground Brace | 2 | 46180212 |
| Latch & Hardware | 1 | 46180272 |
| 10' Panel with Alley Arch | 1 | 46180232 |

Unsheeted System Kit 5

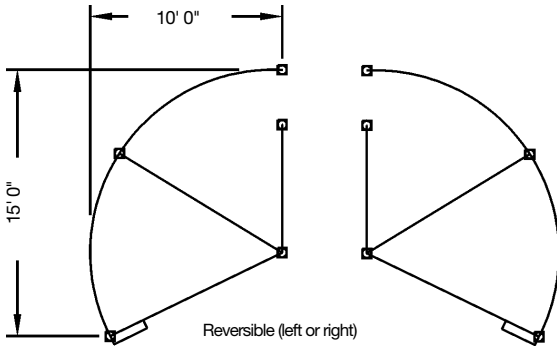

120-degree 2-Panel Sweep Pen.

- **Item # 46079542 (Model # USK5)**

Will make either of the two systems drawn.

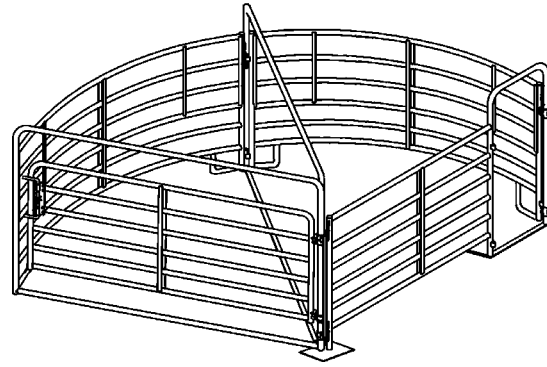

Components

| DESCRIPTION | QTY. | ITEM # |
|----------------------------|------|----------|
| 10' Gate Arch Only | 1 | 46180222 |
| 10' Sweep Pen Gate | 1 | 46160292 |
| Sweep Pen Overhead Brace | 1 | 46160312 |
| 10' Curved Sweep Pen Panel | 2 | 46179572 |
| Flat Ground Brace | 1 | 46180212 |
| Latch & Hardware | 1 | 46180272 |
| 10' Panel with Alley Arch | 1 | 46180232 |

Unsheeted System Kit 6

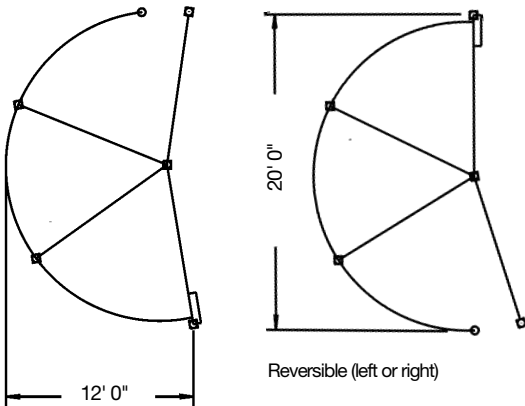

180-degree 3-Panel Sweep Pen with a 10' Straight lead-in Panel.

- **Item # 46079602 (Model # USK6)**

Will make either of the two systems drawn.

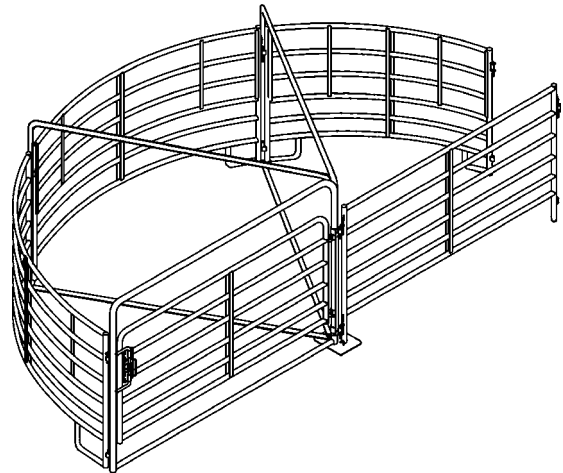

Components

| DESCRIPTION | QTY. | ITEM # |
|--------------------------------|------|----------|
| 10' Gate Arch Only | 1 | 46180222 |
| 10' Sweep Pen Gate | 1 | 46160292 |
| Sweep Pen Overhead Brace | 2 | 46160312 |
| 10' Curved Sweep Pen Panel | 3 | 46179572 |
| Flat Ground Brace | 2 | 46180212 |
| Latch & Hardware | 1 | 46180272 |
| 10' Straight Crowd Alley Panel | 1 | 46160282 |

Unsheeted System Components



10' Sweep Pen Gate Only
• WT 89 lb
Item # 46160292



10' Gate Arch Only
• WT 129 lb
Item # 46180222



10' Curved Sweep Pen Panel
• WT 119 lb
Item # 46179572



10' Panel with Alley Arch
• WT 109 lb
Item # 46180232

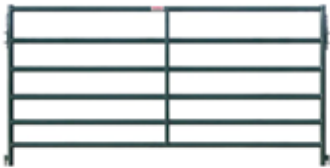

10' Straight Crowd Alley Panel
• WT 94 lb
Item # 46160282

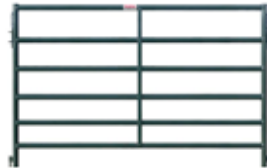

8' Straight Crowd Alley Panel (also
for use w/ platform scales)
• WT 79 lb
Item # 46160272



Non-adjustable Alley Arch
• WT 46 lb
Item # 46112232



Unsheeted Adjustable Alley Arch
• WT 62 lb
Item # 64160612



Sweep Pen Overhead Brace
• WT 31 lb
Item # 46160312



10' Unsheeted Cut Out Panel w/
gate
• WT 113 lb
Item # 46160352



Unsheeted Alley Arch w/ Fender
• WT 74 lb
Item # 64160622



Flat Ground Base
• WT 27 lb
Item # 46180212



10' Unsheeted Crowd Alley Add-on
Includes (2) 46160282 and
(1) 64160612
• WT 248 lb
Item # 46179622



Drop Down No Back
• WT 52 lb
Item # 64160092

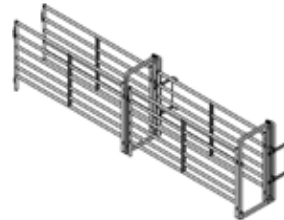

20' Adj. Unsheeted Crowd Alley
• WT 495 lb
Item # 46079592



Roller Gate
• WT 285 lb
Item # 46168892



Latch & Hardware
• 20 lb
Item # 46180272



NOTE: Please call us at 800-447-2751
or visit www.behlencountry.com for
more information.

Care Center

Portable Calving & Sick Pen

- Provides a portable and self-contained working area to assist with calving and calf acceptance (nursing) problems.
- Ideal cattle work area for smaller operations.
- One-man operation and complete portability make it an essential part of any cattle operation.
- Accepts any Behlen Country Headgate.
- The squeeze gate is split, to allow it to swing out of the way to correct nursing problems, graft calves to cows or perform caesareans.
- Comes standard with 10' panels but can be enlarged by using 12', 14' or 16' side panels; the 4' access door provides easy entrance.
- The Split Squeeze Gate can be swung out of the way to convert the Portable Care Center into a pen for treating and containing sick animals.



Care Center

| DESCRIPTION | LB | ITEM # |
|---------------------------------------|-----|----------|
| 10' x 10' Care Center w/CL-5 Headgate | 984 | 62074462 |

Components



Care Center Front Panel
 • WT 379 lb
 Item # 62174502

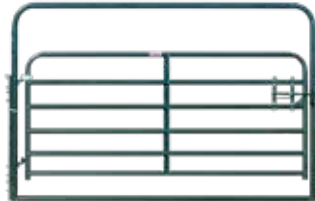

Arch & Gate
 • WT 195 lb
 Item # 62174522

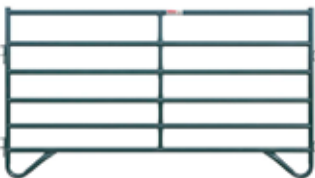

2" 16 ga. Corral Panel (10'x66" high)
 • WT 94 lb
 Item # 44123102



Care Center Hardware (Red)
 • WT 26 lb
 Item # 62174511

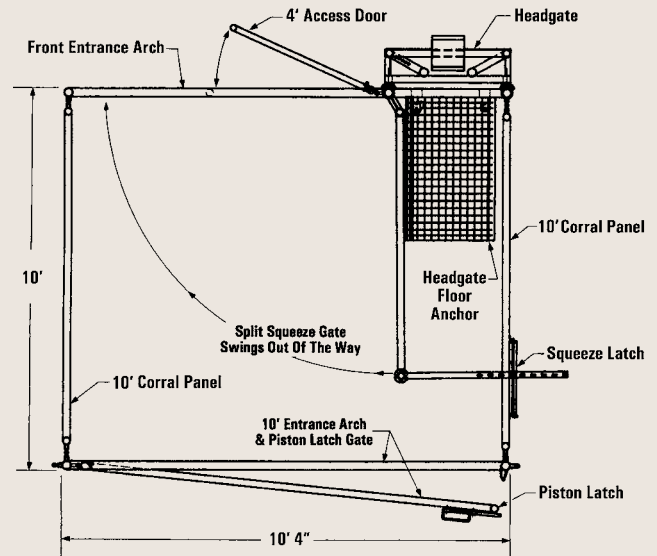

Latch Kit

| DESCRIPTION | LB | ITEM # |
|-------------|----|----------|
| Arm | 15 | 62403031 |
| Base Arm | 1 | 62403021 |

NOTE: Colors pictured may vary from actual product.



Calf Hutch

The Calf Hutch protects calves and small animals from weather extremes. Opaque material prevents overheating in summer temperatures. Rear vent opening to circulate air.

- L 79" x W 54" x H 46"
- WT 83 lb
- Item #68110018

NOTE: Suggested minimum quantity of 2 per drop ship to ensure stability while shipping.



Anchor Stakes

Anchor stakes can be used for a variety of applications including fence corner anchors, tie-downs, guying trees and shrubs, tethering pets, or tent stakes, etc. A pipe or rod can be inserted into the eye of the stake for use as a handle to screw the stake into the ground.



Anchor Stakes

| DESCRIPTION | LB PULL | ORDER IN MULTIPLES | LB | ITEM # |
|-------------------------------|---------|--------------------|-----|----------|
| 15" long, 4" plate w/3/8" rod | 3080 | 12 | 1 | 35150031 |
| 30" long, 4" plate w/3/8" rod | 4180 | 12 | 1.5 | 35150051 |
| 40" long, 6" plate w/1/2" rod | 5940 | 6 | 3 | 35150071 |
| 48" long, 6" plate w/1/2" rod | 13,200 | 6 | 9 | 35150131 |

Steel Post Driver

Steel Post Driver is constructed of heavy piping and capped with a special plug that balances the unit during use. Works with most standard t-post or u-post.

- WT 15 lb
- Item #35150212



Behlen Country® 3-Point Equipment

The equipment you need to manage your land.



Rotary Cutters Medium-Duty

- Get out and get mowing with quick assembly.
- Long-lasting, UV resistant powder coat finish.
- One of the heaviest decks in the industry takes on the abuse.
- Cut in confidence with 6½" deep sides to hold in debris.
- Two premium blades, 3½" wide heat treated, U.S. made forged blades for longer life.
- Ideal for frequent stops and starts, each rotary cutter comes complete with a heavy-duty cast iron 540 RPM gear box.
- Adjustable, laminate puncture-resistant rear wheel.



Medium-Duty

Rotary Cutters & Guards

| DESCRIPTION | CAT | HP | LB | ITEM # |
|----------------------|-----|---------------------|-----|-------------|
| Medium-Duty | | | | |
| 4' MD Cutter | 1 | 45 Max (Shear Bolt) | 417 | 80110040YEL |
| 4' RC Belt Guard Kit | | | 14 | 80110040BLT |
| 5' MD Cutter | 1 | 45 Max (Shear Bolt) | 480 | 80110050YEL |
| 5' RC Belt Guard Kit | | | 16 | 80110050BLT |
| 6' MD Cutter | 1 | 45 Max (Shear Bolt) | 563 | 80110060YEL |
| 6' RC Belt Guard Kit | | | 18 | 80110060BLT |

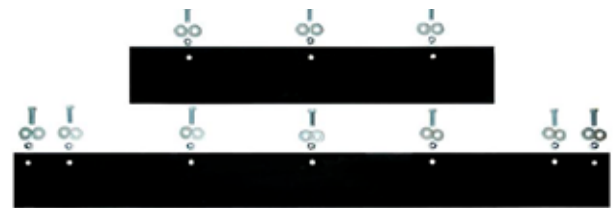

5' RC Belt Guard Kit Pictured

Replacement Parts

| ROTARY CUTTER | LIFT PIN | PTO SHAFT | GEAR BOX | STUMP JUMPER | CUTTER BLADE | BLADE BOLT | BLADE NUT | BLADE WASHER | REPAIR BLADE/BOLT KIT | SAFETY SHEET |
|---------------|----------|-----------|----------|--------------|--------------|------------|-----------|--------------|-----------------------|--------------|
| 4' MD Cutter | 3018352 | 1728011 | 2088052 | 2088026 | 3018433 | 1308012 | 1308015 | 1308016 | 80902040 | 16881000 |
| 5' MD Cutter | 3018352 | 1728012 | 2088028 | 2088026 | 3018434 | 1308012 | 1308015 | 1308016 | 80902050 | 16881000 |
| 6' MD Cutter | 3018352 | 1728012 | 2088028 | 2088026 | 3018435 | 1308012 | 1308015 | 1308016 | 80902060 | 16881000 |

Note: Parts sold as individual units. Not as sets.



Rotary Tiller

The Rotary Tiller features 100% gear driven reliability with the protection of oil lubrication and a slip clutch PTO drive shaft. Self-sharpening, heat treated tines will cut through the toughest soils behind your 25-50 HP tractor. Includes adjustable feet to control tilling depth.

- Heavy-duty cast iron gear box
- All gear driven side gear box
- Self-sharpening heat treated tines
- Long-lasting UV resistant powder coat finish
- Category 1 hookups up to 50 HP max
- Quick hitch compatible

Replacement Parts

Top Gear Box ...2088069
 Side Gear Box ..2088068
 PTO Shaft1728022

Note: Parts sold as individual units. Not as sets.



| DESCRIPTION | CAT | LB | ITEM # |
|------------------|-----|-----|-------------|
| 4' Rotary Tiller | 1 | 635 | 80118040YEL |
| 5' Rotary Tiller | 1 | 687 | 80118050YEL |
| 6' Rotary Tiller | 1 | 751 | 80118060YEL |

Tillage Discs

Heavy & Medium-Duty

The Heavy-Duty Tillage Disc is the heaviest in its class. This tillage disc can be used for general purpose tillage to plowing through even the toughest of soils.

The Medium-Duty Tillage Discs are built for working small plots of land such as gardens and wildlife food plots. The combination of smooth and notch discs easily break up hard ground and prepare it for planting.

- The heavy-duty model features a heavy-duty square steel tube box frame design.
- The medium-duty model features a heavy-duty welded angle frame.
- Adjustable disc gangs (adjust depth and angle).
- Long-lasting sealed bearings
- Long-lasting, UV resistant powder coat finish.
- Category 1 quick hitch compatible up to 45 HP max.



Heavy-Duty

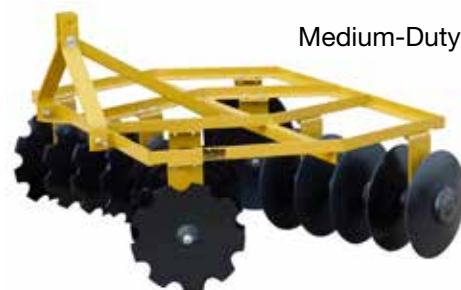

Medium-Duty

| DESCRIPTION | CAT | LB | ITEM # |
|-------------------------------|-----|-----|-------------|
| 6 ½' Heavy-Duty Tillage Disc | 1 | 737 | 80111320YEL |
| 6 ½' Medium-Duty Tillage Disc | 1 | 592 | 80111210YEL |

Grader Blades

Heavy & Medium-Duty

The **Heavy-Duty Adjustable Grader Blades** offer the most freedom to tackle big or small jobs. Tilt, angle and offset capabilities offer extra versatility for exceptional grading, scraping, digging and getting at hard to reach jobs.

The **Medium-Duty Grader Blades** are ideal for many applications including: driveway maintenance, snow removal, dirt and gravel spreading, and more!

Features

- 16" mold board with 6" heat-treated cutting edge.
- Forward and reverse blade angle adjustment.
- 26" offset capabilities either direction - Heavy-duty only.
- Blade is able to tilt 15° either direction - Heavy-duty only.
- 360° blade rotation with 5 settings - index plate adjustment.
- Category 1 quick hitch compatible up to 45 HP max.
- Long-lasting, UV resistant powder coat finish.

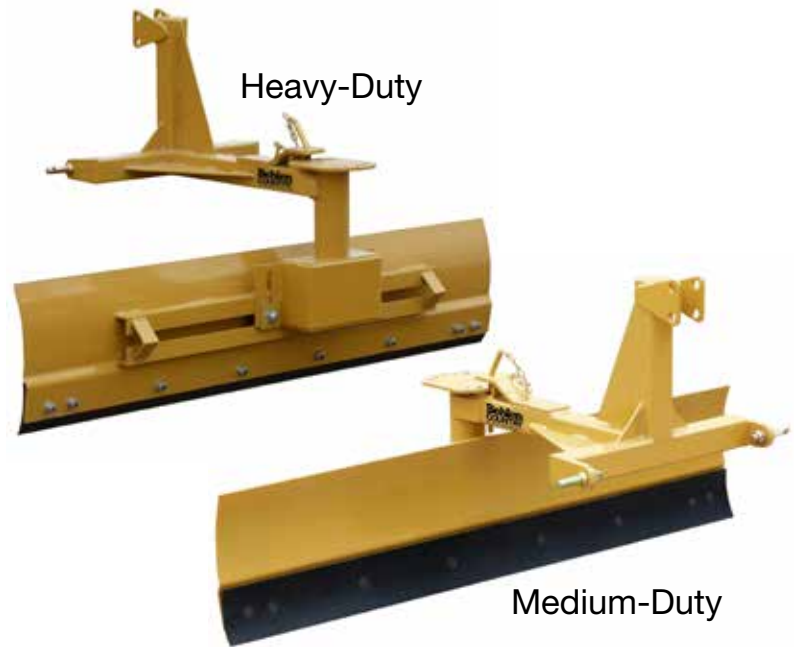

Replacement Parts

| GRADER BLADES | CAT 1 LIFT PIN | CUTTING EDGE |
|--------------------|----------------|--------------|
| 6' HD Grader Blade | 3018352 | 3018379 |
| 7' HD Grader Blade | 3018352 | 3018380 |
| 5' MD Grader Blade | 3018352 | 3018378 |
| 6' MD Grader Blade | 3018352 | 3018379 |
| 7' MD Grader Blade | 3018352 | 3018380 |

Note: Parts sold as individual units. Not as sets.

Grader Blades

| DESCRIPTION | CAT | LB | ITEM # |
|--------------------|-----|-----|-------------|
| Heavy-Duty | | | |
| 6' HD Grader Blade | 1 | 256 | 80110910YEL |
| 7' HD Grader Blade | 1 | 295 | 80110920YEL |
| Medium-Duty | | | |
| 5' MD Grader Blade | 1 | 203 | 80110800YEL |
| 6' MD Grader Blade | 1 | 219 | 80110810YEL |
| 7' MD Grader Blade | 1 | 268 | 80110820YEL |

Box Blade

Behlen Country Box Blades are designed for a multitude of applications including: landscaping, gravel work, driveways, light construction, and leveling. Boxed ends keep the material being worked where you want it.

Features

- Cut as deep as you need with 3 depth adjustments on ripping shanks.
- Long-life shanks with heat-treated cutting edges.
 - 5' model has 5 Shanks.
 - 6' model has 6 Shanks.
 - 7' model has 6 Shanks.
- Front and rear reversible cutting edges.
- Long-lasting UV resistant powder coat finish.
- Category 1 quick hitch compatible.
- Fits Category 1 up to 45 HP max .
- Heavy 4" tool bar holds up during deepest penetration.



Replacement Parts

| BOX BLADES | CAT 1 LIFT PIN | 3" BENT HITCH PIN | SHANKS | CUTTING EDGE |
|--------------|----------------|-------------------|---------|--------------|
| 5' Box Blade | 3018352 | 3018382 | 3018351 | 3018378 |
| 6' Box Blade | 3018352 | 3018382 | 3018351 | 3018379 |
| 7' Box Blade | 3018352 | 3018382 | 3018351 | 3018380 |

Note: Parts sold as individual units. Not as sets.

Box Blades

| DESCRIPTION | CAT | LB | ITEM # |
|--------------|-----|-----|-------------|
| 5' Box Blade | 1 | 391 | 80111100YEL |
| 6' Box Blade | 1 | 457 | 80111110YEL |
| 7' Box Blade | 1 | 487 | 80111120YEL |



Arena Ace™

Create excellent footing for your equestrian needs with the Arena Ace offered by Behlen Country. Whether you have a commercial facility or small training barn, this groomer adjusts to be suitable for a variety of needs and conditions. With ease it creates a good base and finished top surface. This groomer's s-tines can be adjusted to your desired depth, ensuring penetration of the surface and break down of dirt clumps. The leveling bar behind the s-tines levels any hills or valleys. Behind the leveling bar is a set of roller bars that leave a nice, finished surface. This groomer is ideal to be used with category 1 or 2 tractor (up to 50 HP max) and works great in dirt or sand arenas.

- Depth adjustability: Depth Bar 8" and Roller 4"
- Length of tines and/or greatest digging depth: Point 2-1/2" to 5" and Tine is 14" w/point.



Arena Ace™

| DESCRIPTION | L/W/H | TINES | CAT | LB | ITEM # |
|-------------|-----------------|-------|--------|-----|----------|
| Arena Ace | 55" x 96" x 33" | 21 | 1 or 2 | 576 | 80117385 |

Replacement Parts

- Complete S-Tine .. 3018550
- S-Tine Point 3018551
- Brace Arm 80609455
- S-Tine Clamp 3018552

Note: Parts sold as individual units. Not as sets.

Drag Harrow

The Behlen Country Drag Harrows are built with heavy 4" tines and a heavy-duty draw bar. They can be easily reversed to allow for less aggressive leveling. Some of the more common uses are: leveling riding arenas, preparing seed beds, reconditioning driveways, incorporating broadcast seeds, spreading manure in pastures, and beach conditioning. Up to 45 HP max.



Drag Harrow

| DESCRIPTION | W/L | LB | ITEM # |
|----------------|-----------|-----|---------|
| 4' Drag Harrow | 48" x 48" | 66 | 3018371 |
| 6' Drag Harrow | 72" x 48" | 107 | 3018264 |
| 8' Drag Harrow | 96" x 48" | 138 | 3018263 |

Land Plane

Our new Behlen Country Land Plane is perfect for maintaining driveways, gravel roads and for final leveling work. With two cutting edges and a 7' width, you will make short work of big grading jobs.

- Great for grading driveways, leveling land, or reconditioning gravel roads.
- Wide enough to cover your tractor tracks and maintain most drives in two passes.
- 84" grading width.
- Two replaceable cutting edges for maximum grading.
- Rear 3-point hookup quick-hitch compatible.
- Recommended for tractors up to 45 HP max.
- Category 1 quick hitch compatible.
- Replaceable bottom wear strips on side walls.



Land Plane

| DESCRIPTION | CAT | LB | ITEM # |
|---------------|-----|-----|-------------|
| 7' Land Plane | 1 | 533 | 80119070YEL |

Replacement Parts

- CAT 1 Lift Pin 3018352
- Cutting Edge 3018380
- Wear Skid Plate .. 80609110YEL

Note: Parts sold as individual units. Not as sets.

Landscape Rakes

The Medium-Duty Landscape Rakes offer a wide range of versatility from removing debris, to grading gravel roads and spreading top soil. Add the optional wheel kit for height adjustment above grade.

- 360° Rotation with 5 settings - index plate adjustment.
- Quick hitch compatible.
- Category 1 hitch compatible up to 45 HP max.
- Long-lasting, UV resistant powder coat paint.
- Optional Wheel Kit available for all models.



Landscape Rakes

| DESCRIPTION | CAT | LB | ITEM # |
|-------------------|-----|-----|-------------|
| 5' Landscape Rake | 1 | 225 | 80110600YEL |
| 6' Landscape Rake | 1 | 240 | 80110630YEL |
| 7' Landscape Rake | 1 | 280 | 80110640YEL |
| Wheel Kit | - | 40 | 80110665 |

Replacement Parts

| LANDSCAPE RAKES | CAT 1 LIFT PIN | RAKE TINES |
|-------------------|----------------|------------|
| 5' Landscape Rake | 3018352 | 3018367 |
| 6' Landscape Rake | 3018352 | 3018367 |
| 7' Landscape Rake | 3018352 | 3018367 |

Note: Parts sold as individual units. Not as sets.



Middle Buster

The Middle Buster has a sturdy shank and added angle bracing support for the 15" double wing cutting blade. This single row cutting can dig through the toughest of soils.

- Category 1 hitch compatible up to 35 HP max.
- Long-lasting, UV resistant powder coat finish.

| DESCRIPTION | CAT | LB | ITEM # |
|---------------|-----|----|-------------|
| Middle Buster | 1 | 75 | 80111710VEL |

Replacement Parts

CAT 1 Lift Pin...3018352
 Furrower3018368

Note: Parts sold as individual units. Not as sets.



Middle Buster



Cultivator

The One-Row Cultivators are designed for the small farm or acreage owner who wants to maintain small garden and food plots. The cultivator works well for preparing soil for planting, weed control, and incorporating organics into soil.

- Heavy angle iron frame.
- Six heat-treated replaceable cultivator tines.
- Category 1 hitch pins up to 35 HP max.
- Long-lasting, UV resistant powder coat finish.

| DESCRIPTION | CAT | LB | ITEM # |
|-------------|-----|-----|-------------|
| Cultivator | 1 | 116 | 80111500VEL |

Replacement Parts

CAT 1 Lift Pin...3018352
 C Shank3018424
 Field Point.....3018425

Note: Parts sold as individual units. Not as sets.



Sub Soiler

The Sub Soiler is a great way to drain areas where water accumulates and break up compacted soil to improve plant growth. The one piece welded frame ensures years of life, and the replaceable point allows for easy maintenance.

- Category 1 hitch compatible up to 35 HP max.
- Long-lasting, UV resistant powder coat finish.

| DESCRIPTION | CAT | LB | ITEM # |
|-------------|-----|----|-------------|
| Sub Soiler | 1 | 83 | 80111720VEL |

Replacement Parts

CAT 1 Lift Pin...3018352
 Shank.....3018366

Note: Parts sold as individual units. Not as sets.



Sub Soiler



1 Row Hiller

- Creates beautiful raised row garden or raised row crops in tilled or worked soil.
- Sealed bearings.
- Fully adjustable up to 60" wide.
- Quick hitch compatible.
- Category 1 tractors.
- Long-lasting, UV resistant powder coat paint.



| DESCRIPTION | CAT | LB | ITEM # |
|--------------|-----|-----|-------------|
| 1 Row Hiller | 1 | 113 | 80111530YEL |

Replacement Parts

Hiller Disc Blade Assembly3018637

Heavy-Duty Bale Spear

- Long-lasting, constructed of heavy-duty steel.
- Heat-treated bolt on spear makes moving heavy bales easy.
- Category 1 and Category 2 hitch compatible.
- Long-lasting, UV resistant powder coat paint.
- Recommended for lifting bales up to 2,000 lb max.

| DESCRIPTION | CAT | LB | ITEM # |
|---------------|-------|-----|-------------|
| HD Bale Spear | 1 & 2 | 109 | 80112660YEL |

Replacement Parts

CAT 1 & 2 Double Diameter Lift Pin.....3018393

Point.....3018413

Note: Parts sold as individual units. Not as sets.



Bucket Bale Spear

- Mounts to most bucket loaders with a single bolt.
- Heat-treated bolt on spear makes moving bales easy.
- Long-lasting, UV resistant powder coat paint.
- Capable of lifting bales up to 2,000 lb max.

| DESCRIPTION | LB | ITEM # |
|-------------------|----|-------------|
| Bucket Bale Spear | 88 | 80112620YEL |

Replacement Parts

Point..... 3018413

Note: Parts sold as individual units. Not as sets.



Carry All

The Heavy-Duty Carry All is a great companion for your moving needs. A variety of platforms can be constructed for your moving needs. 1,000 lb max capacity and pre-punched legs for easy platform attachment.

| DESCRIPTION | CAT | LB | ITEM # |
|-------------|-----|----|-------------|
| Carry All | 1 | 84 | 80112410YEL |



NOTE: Colors pictured may vary from actual product.

Boom Poles

Medium-Duty

Boom Poles are a great tool for farmers and ranchers. They can assist with loading, lifting and pulling.

- Medium-duty is built to last with schedule 40 tubing construction.
- Category 1 hitch compatible.
- Long-lasting, UV resistant powder coat paint.
- Medium Duty weight capacity 500 lb max.

| DESCRIPTION | CAT | LB | ITEM # |
|--------------|-----|----|-------------|
| MD Boom Pole | 1 | 55 | 80112500YEL |



Medium-Duty

3-Point Hitch Movers

The **3-Point Heavy-Duty Hitch Mover** has a multitude of uses from moving goose neck trailers and ball hitch wagons, to moving boats at the lake. Comes with a 2-5/16" welded top ball, slide-in section for any 2" receiver and category 1 and 2 lift pins. Up to 6,000 lb max.

The **3-Point Standard Hitch Mover** has a multitude of uses it comes with category 1 lift pins. Up to 3,500 lb max.

| DESCRIPTION | LB | ITEM # |
|------------------------|----|-------------|
| Heavy-Duty Hitch Mover | 80 | 80160600YEL |
| Standard Hitch Mover | 48 | 80112560YEL |

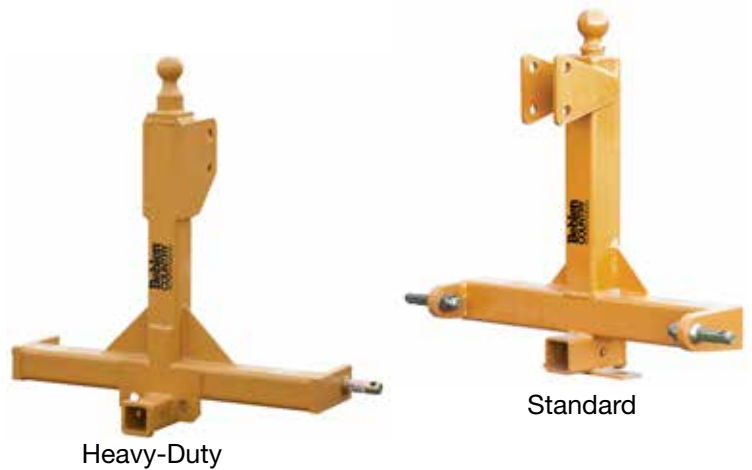

Heavy-Duty

Standard

2" Receiver Wire Un-roller

The Behlen Country 2" Receiver Wire Un-roller helps you complete your fencing projects faster and easier. The 2" Receiver Wire Un-roller attaches to a truck, tractor, or ATV with a 2" receiver and holds most sized rolls of wire.

| DESCRIPTION | LB | ITEM # |
|----------------------------|----|-------------|
| 2" Receiver Wire Un-roller | 26 | 80112530YEL |



Standard Hitch Mover and Wire Un-roller

Spreaders



The 3 Point Spreader features a 850 lb capacity steel hopper (dependent on product) and PTO driven spreader with an in-hopper agitator. Spreads up to 46' with directional spreading available.

- Approximate Capacity 850 lb max
- WT 140 lb

Item # 80112701



The 3-Point Poly Spreader features a 500 lb poly hopper and PTO driven spreader with an in-hopper agitator. Spreads up to 46' with directional spreading available.

- Approximate Capacity 500 lb max
- WT 132 lb

Item # 80112751



The Pull Type Spreader features a 500 lb capacity steel hopper and can be used with an ATV or lawn tractor for a variety of spreading uses.

- Approximate Capacity 500 lb max
- WT 175 lb

Item # 80112741

Post Hole Digger & Augers

POST HOLE DIGGER - Safely and quickly dig post holes with this 3-Point post hole digger and your Category 1 or 2 tractor. Built with a heavy-duty gearbox and driveline and a quick connect to 6 spline PTO, this digger will make quick work of any fencing job.

AUGERS - High quality carbide cutting edge with spiral tip makes for easy digging. Available in 6, 9, and 12 inch diameters.



Auger not included with Post Hole Digger, sold separately.

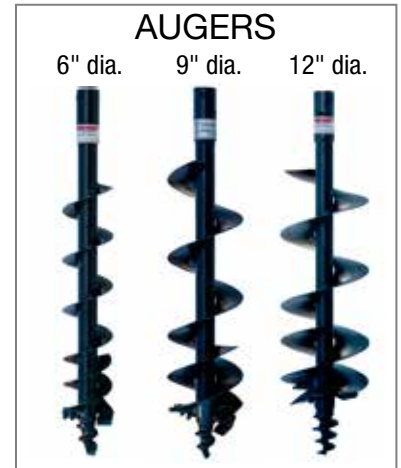

| DESCRIPTION | W/L/H | LB | ITEM # |
|------------------|-------------------|-----|-------------|
| Post Hole Digger | 25" x 72" x 12.5" | 174 | 80113000YEL |
| 6" Dia. Auger | 6" x 50" x 6" | 39 | 80113015 |
| 9" Dia. Auger | 9" x 50" x 9" | 47 | 80113025 |
| 12" Dia. Auger | 12" x 50" x 12" | 63 | 80113035 |

Hitch 'N Plow®

The Hitch 'N Plow allows you to turn your truck, SUV or UTV into a compact tractor. With Hitch 'N Plow you can attach many standard Category 1, non-PTO driven 3-Point implements such as grader blades, landscape rakes and box blades using a standard 2" receiver hitch. Up to 300 lb max.

| DESCRIPTION | W/L/H | LB | ITEM # |
|---------------|----------------|----|----------|
| Hitch 'N Plow | 30" x 28" x 2" | 46 | 80119995 |



Hitch 'N Plow mounted on UTV with Landscape Rake. **Note: Winch is not included.**



Hitch 'N Plow mounted on truck with Grader Blade. **Note: Winch is not included.**

NOTE: Colors pictured may vary from actual product.

Sub-Compact Implements

Behlen Country's Sub-Compact lines start with the strength and versatility of the big boys blended with the agile handling and size you expect from your Sub-Compact (15-25 HP) tractor. All of our Sub-Compact

line implements are fully featured and have the same warranty and quality standards you expect from the rest of our 3-Point lineup.



Rotary Cutter

The Sub-Compact Rotary Cutter is built to last. Supplied with Category 1 lift pins on Category 0 spacing, this is the perfect unit for your sub-compact tractor. Gear box with shear bolt is rated up to 25 HP max. •Cutting thickness 1" •2 Blades

| DESCRIPTION | LB | ITEM # |
|------------------|-----|-------------|
| 4' Rotary Cutter | 394 | 801100300RG |



Box Blade

Ideal for driveway maintenance, snow removal, dirt, gravel spreading and more. Heat-treated blades allow for long lasting durability. Adjustable shanks allow for deep ripping. Category 1 pins on Category 0 spacing. Up to 25 HP max.

| DESCRIPTION | LB | ITEM # |
|--------------|-----|-------------|
| 4' Box Blade | 280 | 801110000RG |



Tillage Disc

The Sub-Compact Tillage Discs are built for working small plots of land such as gardens and wildlife food plots. The combination of smooth and notched discs easily break up hard ground and prepare it for planting. Category 1 pins on Category 0 spacing. Up to 25 HP max.

| DESCRIPTION | LB | ITEM # |
|---------------------|-----|-------------|
| 5 1/2' Tillage Disc | 443 | 801113400RG |



Landscape Rake

The Sub-Compact Landscape Rake is great for clearing a trail, driveway maintenance and numerous other chores. Five forward and five reverse settings. Category 1 pins on Category 0 spacing. Up to 25 HP max.

| DESCRIPTION | LB | ITEM # |
|-------------------|-----|-------------|
| 5' Landscape Rake | 200 | 801106100RG |



Grader Blade

The Sub-Compact Grader Blade is ideal for many applications including driveway maintenance, snow removal, dirt and gravel spreading and much more! Up to 25 HP max.

| DESCRIPTION | LB | ITEM # |
|-----------------|-----|-------------|
| 5' Grader Blade | 190 | 801107100RG |



Includes Sub Soiler Shank

Middle Buster/Sub Soiler Combo

The Middle Buster/Sub Soiler Combo can be used for a multitude of chores. Planting, cultivating and ditching are just a few of these. Category 1 pins on Category 0 spacing. Up to 25 HP max.

| DESCRIPTION | LB | ITEM # |
|--------------------------------|----|-------------|
| Middle Buster/Sub Soiler Combo | 37 | 801117000RG |

Best in Value Dog Kennels



Value Chain Link Kennels

The Value Chain Link Kennels feature cast aluminum square corner fittings for ultimate strength and animal safety. The pre-assembled panels feature center vertical support bars for added strength as well as 1" clearance under the kennels and open bottoms on the vertical tubing for drainage.



Latch



Butterfly Clamps (8)



Butterfly Clamps (4)



NOTE: Please call us at 800-447-2751 or visit www.behlencountry.com for more information.

| DESCRIPTION | L/W/H | PALLET QTY | LB | ITEM # |
|-------------|-------|------------|----|--------|
|-------------|-------|------------|----|--------|

VALUE CHAIN LINK KENNELS

| | | | | |
|-----------------|----------------|---|-----|--------|
| Complete Kennel | 10' x 10' x 6' | 4 | 182 | 441006 |
|-----------------|----------------|---|-----|--------|

PANELS

| | | | | |
|-------------------|----------|----|----|--------|
| Single Door Panel | 10' x 6' | 16 | 59 | 401106 |
| Expansion Panel | 10' x 6' | 16 | 41 | 400106 |

ACCESSORIES FOR VALUE CHAIN LINK KENNELS

| ACCESSORIES | SHIPS UPS | LB | ITEM # |
|-----------------------------------|-----------|----|----------|
| Latch | X | 1 | 900975A |
| Butterfly Clamps - 4 pair per pkg | X | 1 | 900319AM |
| Butterfly Clamps - 8 pair per pkg | X | 2 | 900319BM |



NOTE: Colors pictured may vary from actual product.

**The strongest and most durable kennels available.
25% heavier wire mesh than the competition.
Made to contain the most active dogs.**

Magnum Kennels™

Powder Coated Features

- Rust inhibiting zinc rich primer, top coated with our premium gray powder coat paint provides an attractive appearance and longer life.
- Robust 1-5/8" tubing and heavy 6 gauge 2" x 4" mesh.
- Configurable to fit any size yard or dog.
- Stronger, more secure and attractive alternative to chain link kennels.
- Easy to assemble, no tools required.
- Wire mesh and sun shade tops available.
- Residential use only.
- Made in the U.S.A.

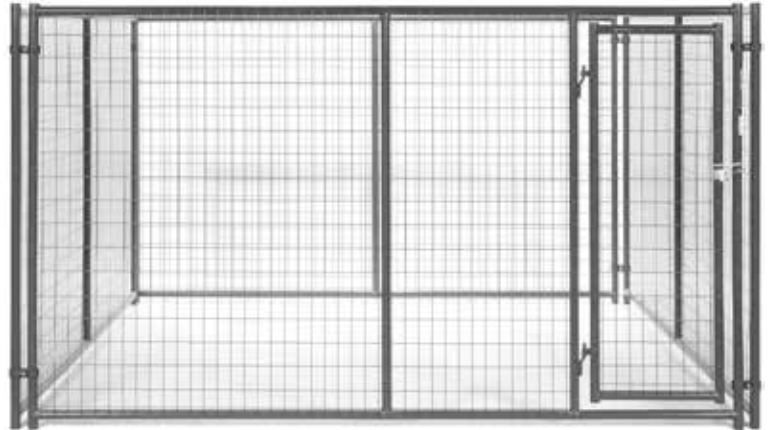

Magnum Kennels™ make great chicken pens!

| DESCRIPTION | L/W/H | DOORS | LB | ITEM # |
|------------------------------|----------------|-------|-----|----------|
| POWDER COATED KENNELS | | | | |
| Complete Kennel | 10' x 10' x 6' | 1 | 298 | 38100227 |
| Complete Kennel | 5' x 10' x 6' | 1 | 236 | 38100337 |
| PANELS | | | | |
| Single Door Panel | 10' x 6' | 1 | 86 | 38100017 |
| Double Door Panel | 10' x 6' | 2 | 132 | 38100097 |
| Single Door Panel | 5' x 6' | 1 | 53 | 38100077 |
| Expansion Panel | 10' x 6' | 0 | 68 | 38140067 |
| Expansion Panel | 5' x 6' | 0 | 41 | 38100087 |



Magnum Kennel™ Configurations

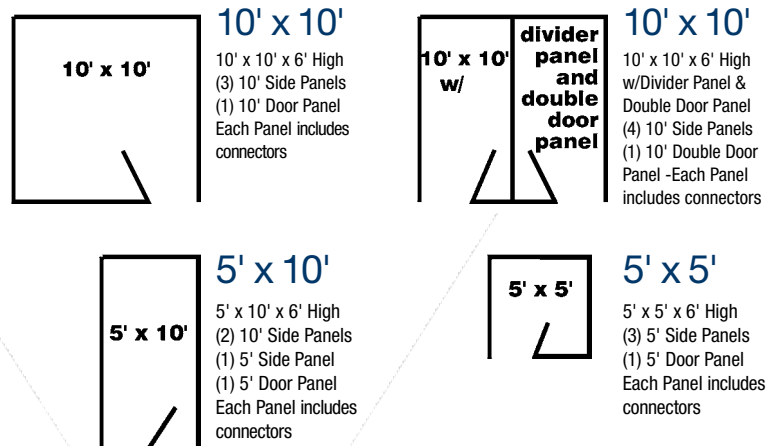

No kennel outlasts the hot-dipped Magnum Kennel™!

Magnum Kennels™

Hot-Dipped Galvanized Features

- Rust inhibiting hot-dipped galvanized coating for years of rust-free performance.
- Stronger than other welded wire kennels due to the center vertical support and heavy gauge mesh.
- Long lasting 2" x 4" 6 gauge hot-dipped mesh - the heaviest in the industry.
- Heavy 1-5/8" hot-dipped galvanized tubular frame.
- Plated, lockable, slam latch.
- Modular and portable.
- Recommended for residential and commercial operations.
- Easy assembly, no tools required.
- Steel mesh and sun shade tops available.
- Made in the U.S.A.

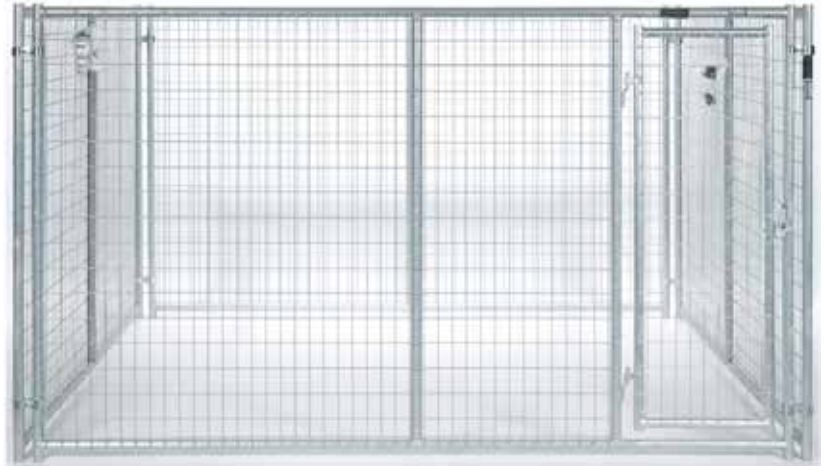

Accessories



Steel Mesh Top



Latch Kit



Lift Latch Kit



Butterfly Clamp



Butterfly Clamp



Plastic Cap

| DESCRIPTION | L/W/H | DOORS | LB | ITEM # |
|--|----------------|-------|-----|----------|
| HOT-DIPPED GALVANIZED MAGNUM KENNELS™ | | | | |
| Complete Kennel | 10' x 10' x 6' | 1 | 353 | 38100229 |
| Complete Kennel | 5' x 10' x 6' | 1 | 279 | 38100339 |
| PANELS | | | | |
| Single Door Panel | 10' x 6' | 1 | 101 | 38100019 |
| Double Door Panel | 10' x 6' | 2 | 120 | 38100099 |
| Single Door Panel | 5' x 6' | 1 | 63 | 38100079 |
| Expansion Panel | 10' x 6' | 0 | 84 | 38140069 |
| Expansion Panel | 5' x 6' | 0 | 48 | 38100089 |

| ACCESSORIES FOR MAGNUM KENNELS™ | | | | | |
|--|-------------------|------------------|-----------|-----|----------|
| ACCESSORIES | POWDER COAT MODEL | HOT-DIPPED MODEL | SHIPS UPS | LB | ITEM # |
| Steel Mesh Top 10' x 10' | X | | | 136 | 38140027 |
| Steel Mesh Top 5' x 10' | X | | | 62 | 38140017 |
| Steel Mesh Top 5' x 10' | | X | | 68 | 38140019 |
| Sunblock Top 10' x 10' | X | X | X | 5 | 900901 |
| Latch Kit | | X | X | 1 | 38900128 |
| Lift Latch Kit | X | | X | 1 | 38900079 |
| Butterfly Clamps - 2 pair per pkg | | X | X | 2 | 38900069 |
| Butterfly Clamps - 2 pair per pkg | X | | X | 2 | 38900067 |
| Plastic Cap | X | X | X | .02 | 1448107 |



NOTE: Please call us at 800-447-2751 or visit www.behlencountry.com for more information.



Behlen[®] COUNTRY

Farm & Ranch Equipment

ALL EQUIPMENT IS PROTECTED BY OUR EXCLUSIVE ONE-YEAR WARRANTY

(Unless listed otherwise)

AGRICULTURAL PRODUCT WARRANTY:

Behlen Country warrants to the original purchaser that its products that prove to be defective in materials or workmanship within one year from the date of purchase will be repaired or replaced at Behlen Country's option, free of charge, F.O.B. closest plant location, U.S.A.

Energy-free, electric and insulated drinker bodies have a limited five-year warranty from date of purchase. Component parts, such as electric motors, heaters, valves and controls that are manufactured by a company other than Behlen Country, have a one-year limited warranty by Behlen Country. Additional warranties by the manufacturer of these items may also apply.

All poly round tanks have a two-year limited warranty. All poly round end tanks have a three-year limited warranty. All fence panels have a five-year limited warranty. All Champion gates have a limited lifetime warranty.

WHAT IS NOT COVERED BY THE WARRANTY:

This warranty does not cover:

1. Assemblages not made in accordance with installation instructions, and defects arising thereof.
2. When the operation of the product varies from our operating instructions.
3. Malfunction or defect resulting from misuse, negligence, alteration, accident, natural disasters, failure to reasonably care for, or lack of performance of required maintenance.
4. Loss of time, inconvenience, loss-of-use of product, or any or all CONSEQUENTIAL DAMAGES.
5. Use of the product in industrial application, or any application not involved in the business of farming or ranching.

SERVICE PARTS POLICY:

1. Repair parts are provided for all current models.
2. Limited availability of common service parts for recently discontinued items.
3. Repair parts will not be manufactured for obsoleted equipment and can only be supplied subject to availability in inventory.

FOR QUESTIONS REGARDING WARRANTY:

Discuss the problem with your dealer or distributor, or contact a Customer Service Representative toll-free at 1-800-447-2751. Proof of purchase and date of purchase are required.



behlencountry.com



800-447-2751



402-563-7447



E-Mail: answers@behlencountry.com

Scan the QR
Code for a
direct link to our
website.



WORLD HEADQUARTERS:
Behlen Mfg. Co.
P.O. Box 569
Columbus, NE 68602-0569

WEST COAST PLANT:
Behlen Country
4000 23rd St.
Baker City, OR 97814

TEXAS PLANT:
Behlen Country
1221 McGregor Drive
McGregor, TX 76657